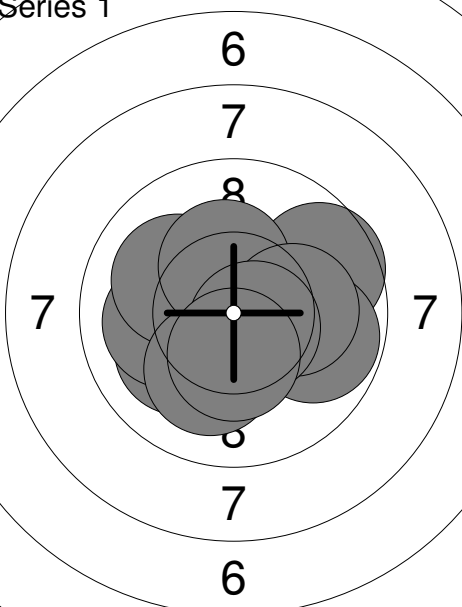
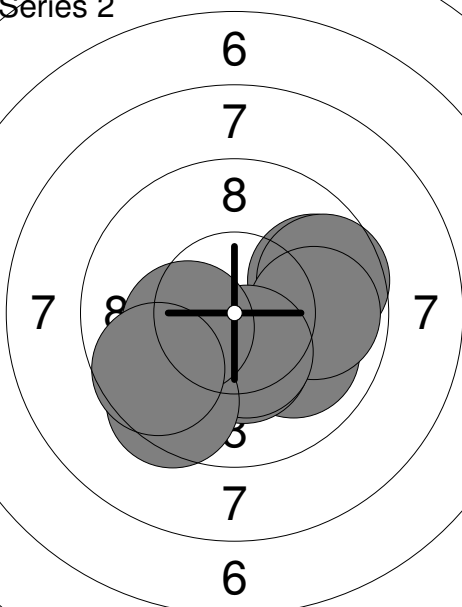
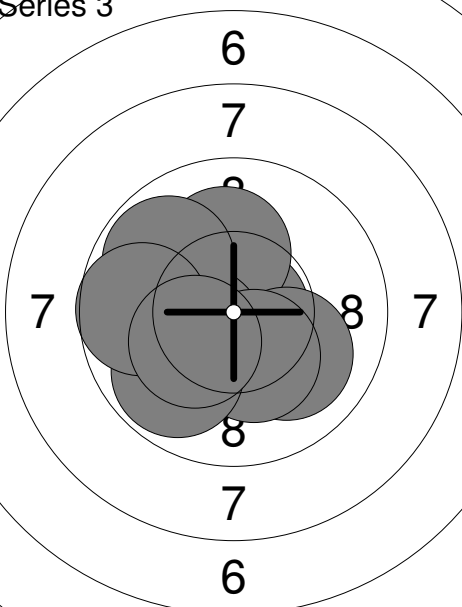
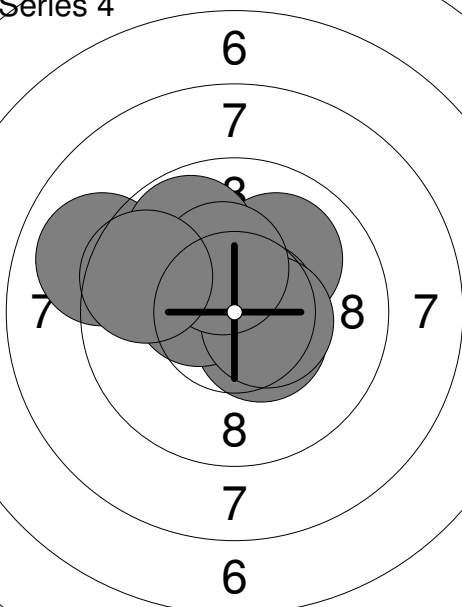
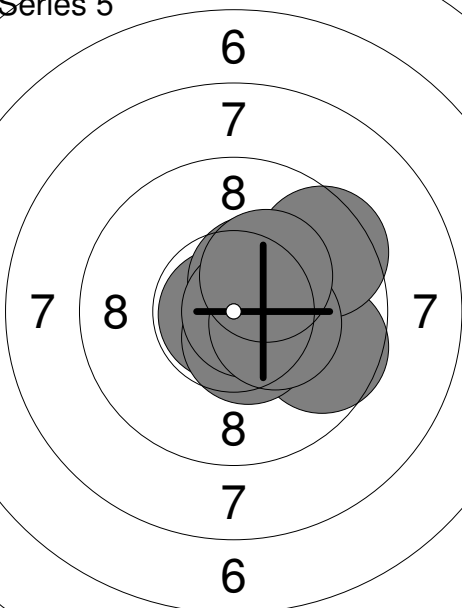
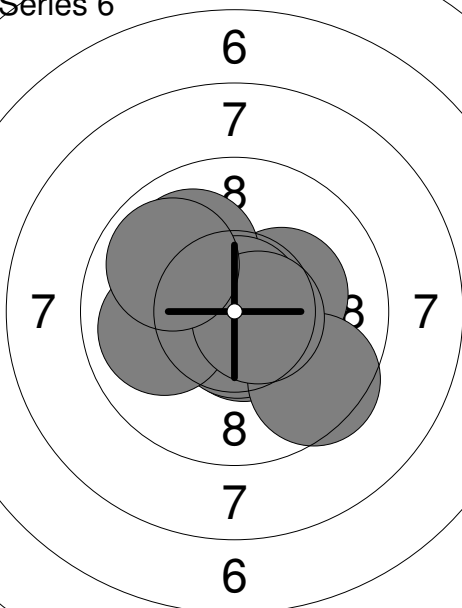
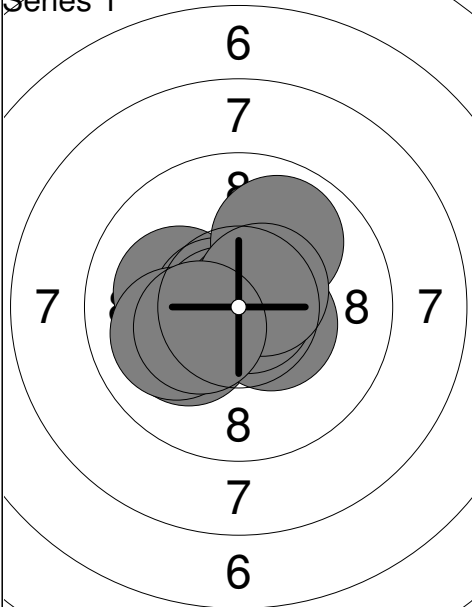
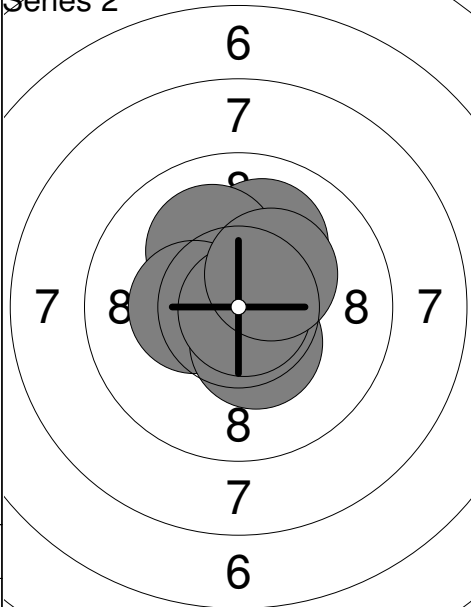
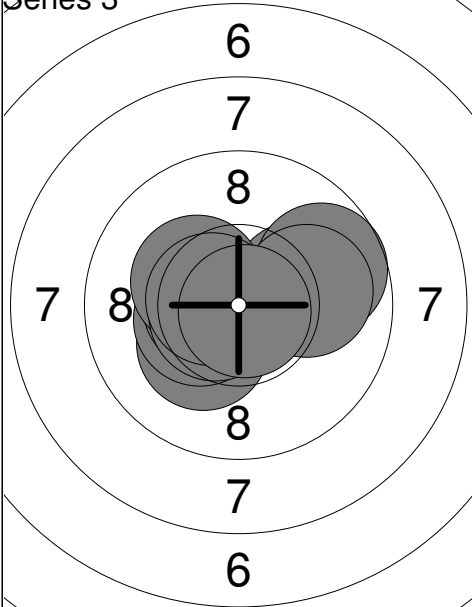
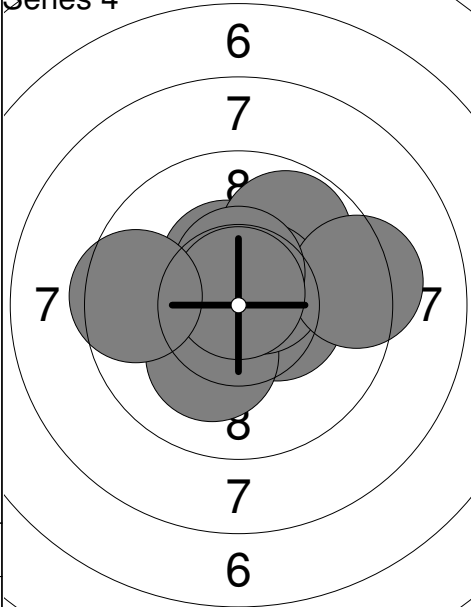
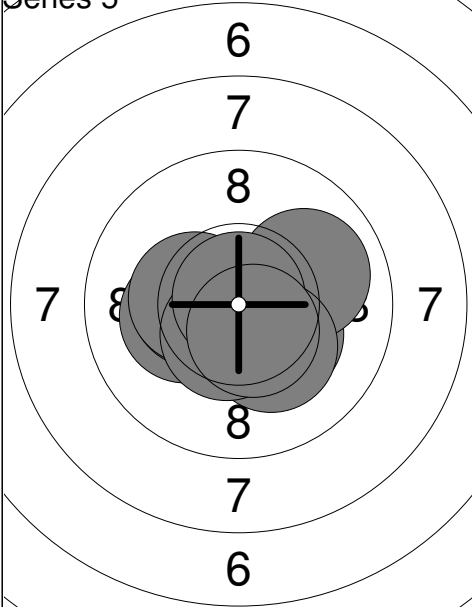
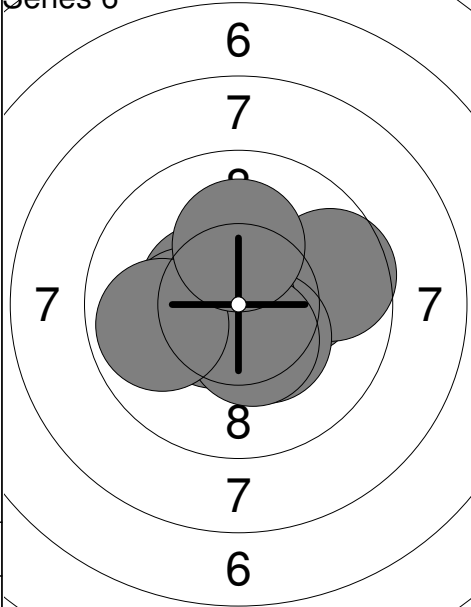
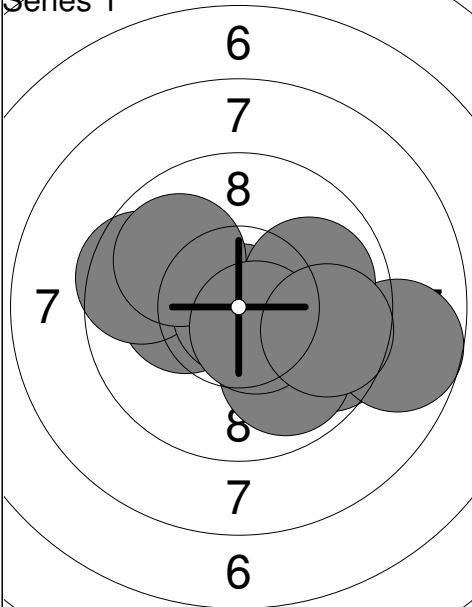
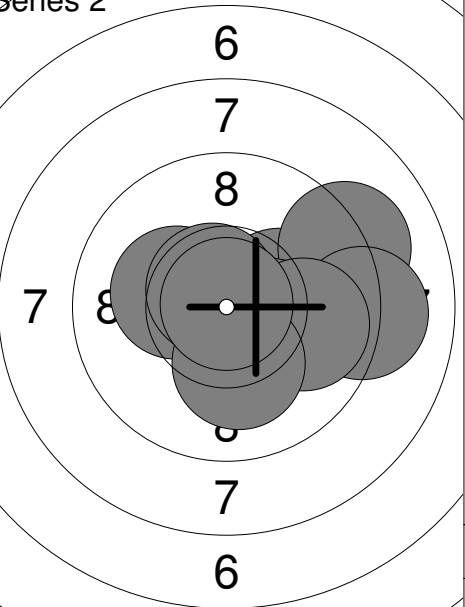
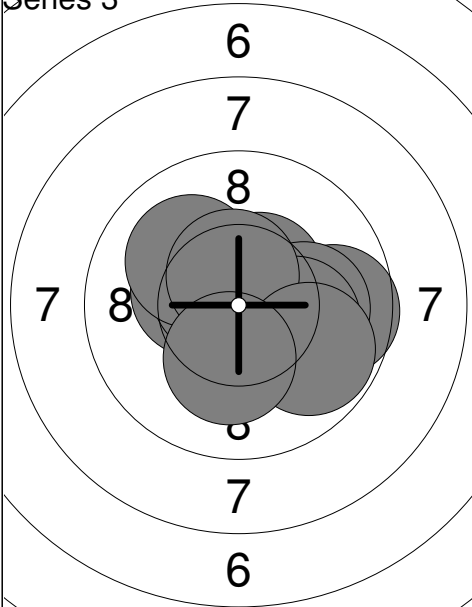
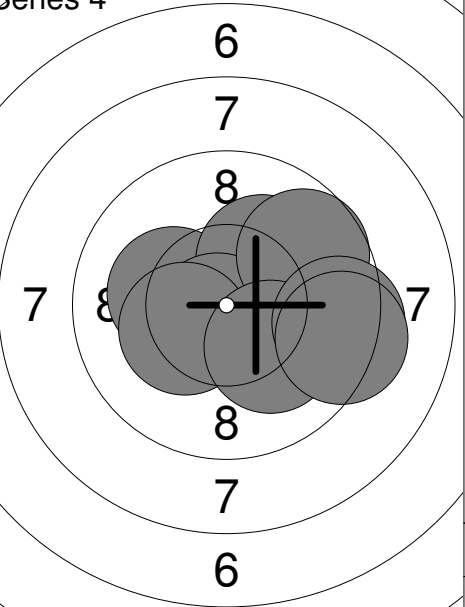
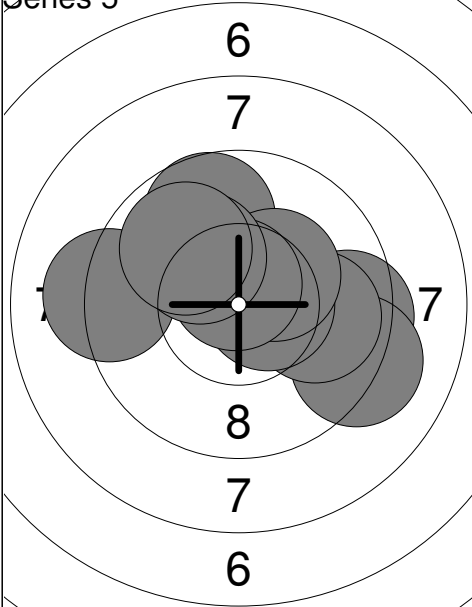
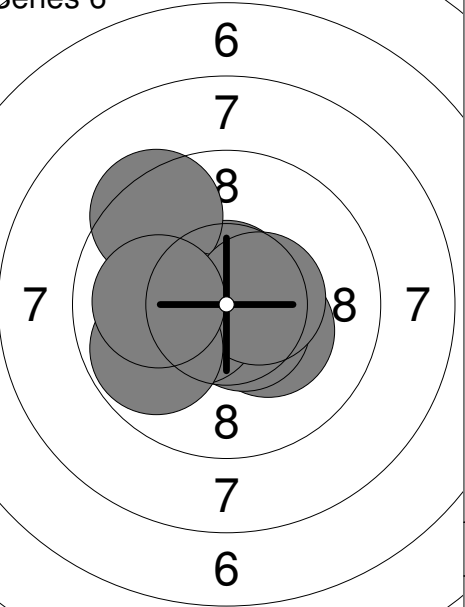

Relay	Lane	Jenni Leppänen	
1 Air		V-SA	ARW
17.11.2019		Kankaanpaaopen 17.11	Kankaanpään ampumaurheilijat
Series 1		1: 9.9 ↗ 2: 10.4x → 3: 9.8 ← 4: 9.8 ↑ 5: 10.1 ↓ 6: 9.7 ↖ 7: 10.8x ↑ 8: 9.9 ← 9: 10.6x ↗ 10: 9.3 ↑ Series 100.3 100.3	Series 2
			1: 10.3x ↖ 2: 9.8 → 3: 10.8x ↗ 4: 10.1 ↗ 5: 10.3x ↗ 6: 10.2x ↖ 7: 10.1 → 8: 10.0 ↑ 9: 9.9 → 10: 10.2x ↗ Series 101.7 202.0
Series 3		1: 9.9 ← 2: 9.9 ↑ 3: 10.3x → 4: 10.9x ↑ 5: 10.1 ↑ 6: 10.6x ← 7: 10.7x ↗ 8: 10.3x ↑ 9: 10.0 ↓ 10: 9.3 ↓ Series 102.0 304.0	Series 4
			1: 10.3x ↖ 2: 10.7x → 3: 10.7x ← 4: 9.4 → 5: 10.1 → 6: 10.1 ← 7: 10.1 ↓ 8: 10.7x ↑ 9: 10.0 ↖ 10: 10.0 ↓ Series 102.1 406.1
Series 5		1: 10.1 ↑ 2: 10.4x ← 3: 10.2x ↓ 4: 10.2x ↗ 5: 10.2x ↑ 6: 10.0 → 7: 10.2x ↖ 8: 10.5x ↑ 9: 10.4x ↓ 10: 10.9x → Series 103.1 509.2	Series 6
			1: 10.9x ↖ 2: 10.0 ↓ 3: 10.0 → 4: 10.2x ↖ 5: 10.6x ↓ 6: 10.0 ↓ 7: 10.0 → 8: 10.1 ← 9: 10.0 ↗ 10: 10.3x → Series 102.1 611.3

Relay	Lane	Tea Sikanen	
1 Air		PiekSA	ARW
17.11.2019		Kankaanpaaopen 17.11	Kankaanpään ampumaurheilijat
Series 1		1: 10.1 ↙ 2: 10.0 ← 3: 10.1 ↖ 4: 10.1 ↓ 5: 9.6 → 6: 10.3x ↑ 7: 9.8 → 8: 10.1 → 9: 10.6x ↘ 10: 10.4x ↓ Series 101.1 101.1	Series 2  1: 10.3x ↘ 2: 10.0 → 3: 9.8 → 4: 10.3x ↓ 5: 9.6 → 6: 9.9 → 7: 10.4x ↓ 8: 9.5 ↓ 9: 10.3x ← 10: 9.6 ↖ Series 99.7 200.8
Series 3		1: 10.8x → 2: 10.1 ↑ 3: 10.3x ↙ 4: 10.0 ↘ 5: 10.3x ↓ 6: 10.0 ↖ 7: 9.8 ↘ 8: 9.8 ↖ 9: 9.7 ← 10: 10.3x ↙ Series 101.1 301.9	Series 4  1: 10.0 ↗ 2: 10.3x ↖ 3: 10.5x ↘ 4: 9.0 ↖ 5: 9.8 ↗ 6: 10.7x → 7: 10.4x ↙ 8: 10.5x → 9: 10.3x ↑ 10: 9.6 ↖ Series 101.1 403.0
Series 5		1: 10.3x ↗ 2: 9.6 → 3: 10.5x → 4: 10.8x ← 5: 10.5x ↓ 6: 9.5 → 7: 10.5x ↗ 8: 10.7x → 9: 10.3x → 10: 10.3x ↗ Series 103.0 506.0	Series 6  1: 10.7x ← 2: 10.3x → 3: 10.6x ↓ 4: 10.0 ↖ 5: 10.7x ↓ 6: 10.8x ↑ 7: 10.0 ← 8: 9.5 ↘ 9: 10.6x → 10: 9.9 ↖ Series 103.1 609.1

Relay	Lane	Anna-Maria Siivonen		
1 Air		TSA	ARW	
17.11.2019		Kankaanpaaopen 17.11	Kankaanpään ampumaurheilijat	
Series 1 	1: 10.5x ←	Series 2 	1: 10.4x ↘	
	2: 10.7x ←		2: 10.3x ↘	
	3: 9.4 ↓		3: 10.4x ↗	
	4: 9.9 ↑		4: 10.4x ←	
	5: 10.5x ←		5: 10.2x ↑	
	6: 10.6x →		6: 10.4x ←	
	7: 10.2x →		7: 10.7x ←	
	8: 10.5x →		8: 10.0 ↖	
	9: 10.2x ↗		9: 10.1 ↓	
	10: 10.7x ↗		10: 10.5x ↓	
	Series 103.2		Series 103.4	
	103.2		206.6	
Series 3 	1: 10.5x ←	Series 4 	1: 10.2x →	
	2: 10.3x ↗		2: 10.2x ←	
	3: 9.6 ↗		3: 10.8x →	
	4: 10.1 →		4: 10.3x →	
	5: 9.5 ↓		5: 10.2x ↓	
	6: 10.6x ←		6: 10.8x ↗	
	7: 9.9 ↖		7: 10.2x ↓	
	8: 10.7x ↓		8: 10.6x ←	
	9: 10.2x ↖		9: 10.0 ↘	
	10: 10.8x ↑		10: 10.5x ←	
	Series 102.2		Series 103.8	
	308.8		412.6	
Series 5 	1: 10.2x ↗	Series 6 	1: 10.7x ←	
	2: 10.5x ↘		2: 10.8x ↓	
	3: 10.3x ↓		3: 10.5x ↘	
	4: 10.2x ↘		4: 10.9x →	
	5: 10.5x ↑		5: 10.7x ↓	
	6: 10.8x ↖		6: 10.3x ↘	
	7: 10.6x ↘		7: 10.2x ←	
	8: 9.9 ↖		8: 10.4x ↘	
	9: 10.5x ↗		9: 10.4x →	
	10: 10.8x ↘		10: 10.0 ←	
	Series 104.3		Series 104.9	
	516.9		621.8	

Relay	Lane	Pauliina Frilander	
1 Air		PiekSA	ARW
17.11.2019		Kankaanpaaopen 17.11	Kankaanpään ampumaurheilijat
Series 1		1: 10.1 ← 2: 10.6x ← 3: 10.1 ← 4: 10.7x ← 5: 10.4x ↘ 6: 9.9 ↗ 7: 10.8x → 8: 10.5x ↗ 9: 10.0 ← 10: 10.3x ← Series 103.4 103.4	Series 2  1: 10.2x ↗ 2: 10.8x ↓ 3: 10.4x ↗ 4: 10.0 ↗ 5: 10.7x ↑ 6: 10.1 ↖ 7: 10.3x ← 8: 10.4x ↓ 9: 10.8x ↘ 10: 10.3x ↗ Series 104.0 207.4
Series 3		1: 10.2x ↘ 2: 10.4x ← 3: 10.5x ← 4: 10.1 → 5: 9.7 → 6: 10.3x ↖ 7: 10.6x ← 8: 10.5x ← 9: 10.0 → 10: 10.8x ↓ Series 103.1 310.5	Series 4  1: 10.4x → 2: 10.6x ↗ 3: 10.4x ↑ 4: 9.8 ↗ 5: 10.2x ↓ 6: 10.5x ↗ 7: 9.3 → 8: 10.5x ↑ 9: 10.8x ↑ 10: 9.5 ← Series 102.0 412.5
Series 5		1: 10.3x ↓ 2: 10.2x ← 3: 10.4x ← 4: 10.0 → 5: 10.3x ← 6: 10.5x ↓ 7: 10.2x ↓ 8: 10.5x ↓ 9: 10.8x ↑ 10: 10.5x ↓ Series 103.7 516.2	Series 6  1: 10.2x → 2: 9.6 → 3: 10.5x ↖ 4: 10.4x ↓ 5: 10.8x ← 6: 10.5x ↖ 7: 10.2x ← 8: 10.4x ↓ 9: 9.8 ← 10: 10.1 ↑ Series 102.5 618.7

Relay	Lane	Mira Ojanen			
1 Air		PuKu	ARW		
17.11.2019		Kankaanpaaopen 17.11	Kankaanpään ampumaurheilijat		
Series 1		1: 9.6 → 2: 9.9 ↓ 3: 10.2x ← 4: 9.6 ← 5: 8.7 → 6: 10.9x ↓ 7: 9.9 ↗ 8: 9.9 → 9: 10.6x ↓ 10: 9.7 →	Series 2		1: 10.2x ← 2: 10.2x → 3: 9.4 → 4: 9.1 ↗ 5: 10.3x → 6: 9.1 → 7: 9.9 → 8: 10.2x ↓ 9: 10.6x ↖ 10: 10.9x ↑
	Series 99.0		Series 99.9		
	99.0		198.9		
Series 3		1: 10.3x ← 2: 10.4x ↗ 3: 9.7 → 4: 10.6x ↖ 5: 10.1 → 6: 10.1 → 7: 10.0 ↗ 8: 10.5x ↑ 9: 9.8 ↓ 10: 10.2x ↓	Series 4		1: 10.8x → 2: 10.2x ← 3: 10.1 ↗ 4: 10.7x ↓ 5: 10.3x ← 6: 9.6 → 7: 9.7 ↗ 8: 10.1 ↓ 9: 9.4 → 10: 9.3 →
	Series 101.7		Series 100.2		
	300.6		400.8		
Series 5		1: 9.7 ↑ 2: 9.4 → 3: 9.2 ↓ 4: 9.9 → 5: 10.5x → 6: 10.3x ↗ 7: 10.6x ↑ 8: 9.2 ← 9: 10.1 ↗ 10: 9.9 ↖	Series 6		1: 10.2x ← 2: 10.8x ↑ 3: 10.7x ↑ 4: 9.4 ↖ 5: 10.3x → 6: 10.6x ↓ 7: 10.4x ← 8: 10.5x → 9: 9.8 ← 10: 10.0 ←
	Series 98.8		Series 102.7		
	499.6		602.3		

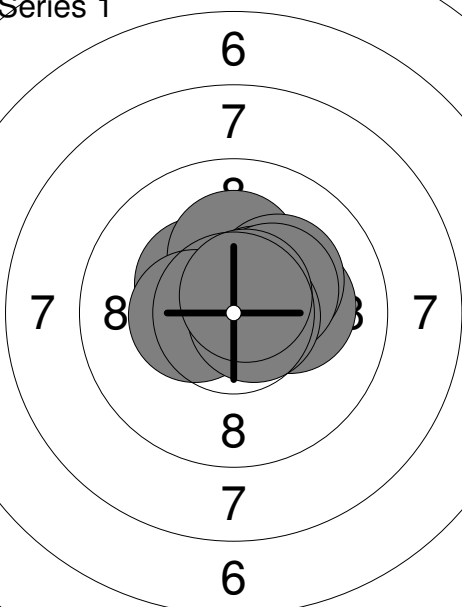
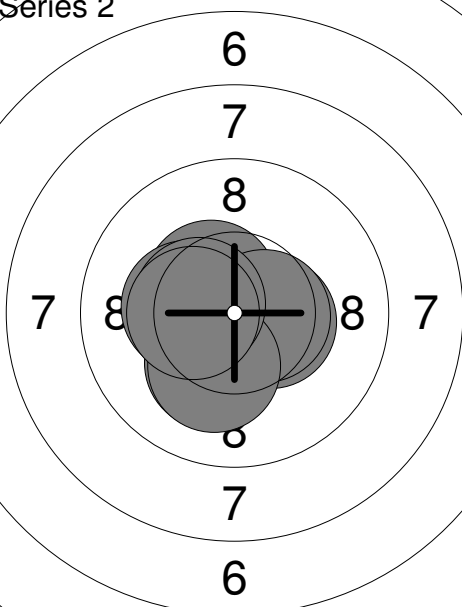
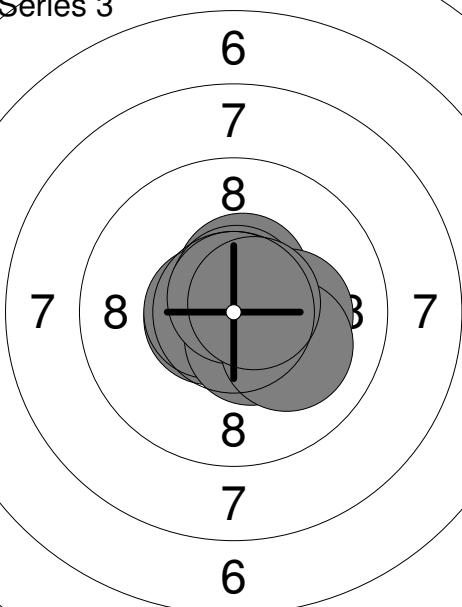
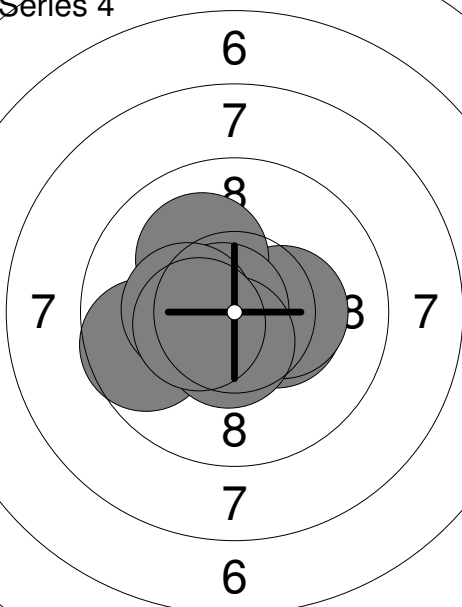
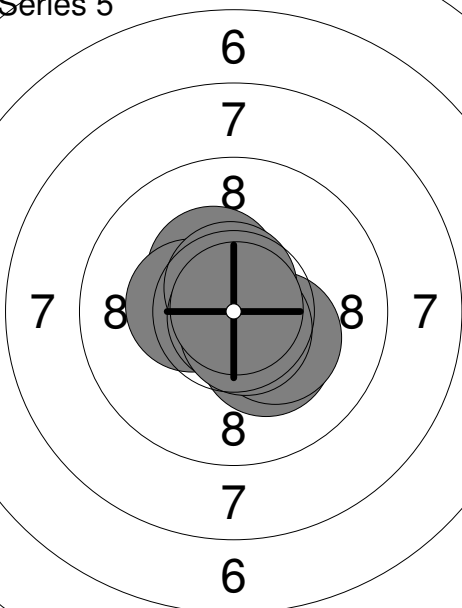
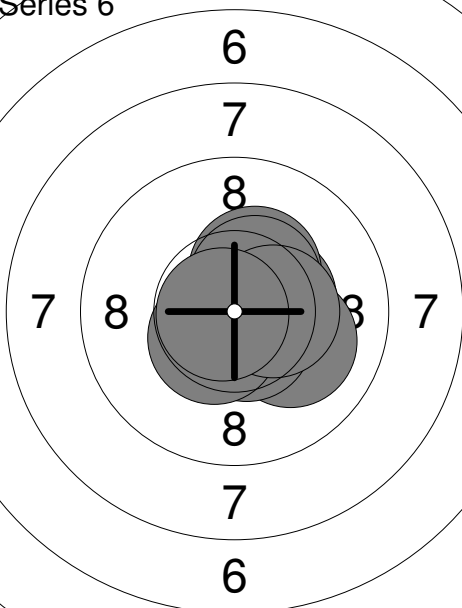
Relay	Lane	Marianne Palo		
1 Air	12	IMAS	ARW	
17.11.2019	Kankaanpaaopen 17.11	Kankaanpään ampumaurheilijat		
Series 1		1: 10.3x ↖ 2: 10.2x → 3: 10.6x ↑ 4: 10.2x ↑ 5: 10.2x ↗ 6: 10.5x ↗ 7: 10.3x ↗ 8: 10.4x ← 9: 10.7x → 10: 10.6x ↗ Series 104.0 104.0	Series 2 	1: 10.4x → 2: 10.9x 3: 10.4x ↖ 4: 10.6x ← 5: 10.3x ← 6: 10.2x ↓ 7: 10.5x → 8: 10.2x ↓ 9: 10.4x ← 10: 10.4x ← Series 104.3 208.3
Series 3		1: 10.6x ← 2: 10.6x ↗ 3: 10.5x ↑ 4: 10.6x ← 5: 10.5x ↓ 6: 10.7x ↑ 7: 10.7x ↑ 8: 10.2x → 9: 10.1 ↓ 10: 10.6x ↗ Series 105.1 313.4	Series 4 	1: 10.6x ← 2: 10.4x → 3: 10.3x → 4: 10.4x ← 5: 9.6 ← 6: 10.1 ↖ 7: 10.8x ← 8: 10.5x ↓ 9: 10.3x ← 10: 10.4x ← Series 103.4 416.8
Series 5		1: 10.3x ↖ 2: 10.2x ↓ 3: 10.6x ← 4: 10.3x ↓ 5: 10.8x ← 6: 10.4x ← 7: 10.6x ↑ 8: 10.9x ↓ 9: 10.6x ↓ 10: 10.9x ↗ Series 105.6 522.4	Series 6 	1: 10.9x ↓ 2: 10.1 → 3: 10.4x → 4: 10.6x ↓ 5: 10.7x → 6: 10.3x ↗ 7: 10.4x ↓ 8: 10.4x ↗ 9: 10.4x → 10: 10.8x ← Series 105.0 627.4

Relay	Lane	Inka Havukainen		
1 Air	13	KitA	ARW	
17.11.2019	Kankaanpaaopen 17.11	Kankaanpään ampumaurheilijat		
Series 1		1: 10.2x ↘ 2: 10.5x ↘ 3: 10.0 → 4: 10.8x ↘ 5: 10.4x ← 6: 10.4x ↖ 7: 10.8x ← 8: 10.7x ← 9: 10.3x ↖ 10: 10.3x → Series 104.4 104.4	Series 2	 1: 10.9x → 2: 10.6x → 3: 10.6x ↗ 4: 9.8 ↗ 5: 9.8 → 6: 9.6 ← 7: 10.1 ↖ 8: 10.6x ↗ 9: 10.6x → 10: 10.4x → Series 103.0 207.4
Series 3		1: 10.1 → 2: 10.2x ← 3: 9.9 ↗ 4: 9.4 ↖ 5: 10.6x ← 6: 10.2x ← 7: 9.9 ↖ 8: 10.4x ↑ 9: 10.4x ↑ 10: 10.5x → Series 101.6 309.0	Series 4	 1: 10.5x ↙ 2: 10.8x ↘ 3: 10.3x → 4: 10.5x → 5: 10.5x ↘ 6: 9.5 ↗ 7: 10.3x ↗ 8: 10.8x ↘ 9: 10.1 ↑ 10: 9.6 → Series 102.9 411.9
Series 5		1: 9.8 ← 2: 10.2x → 3: 10.1 ↗ 4: 10.0 ↗ 5: 10.3x ↖ 6: 10.5x ↙ 7: 10.6x → 8: 10.7x → 9: 10.5x ← 10: 10.6x ↗ Series 103.3 515.2	Series 6	 1: 9.7 ← 2: 10.3x → 3: 10.4x ← 4: 10.3x → 5: 9.6 ← 6: 10.5x ← 7: 10.6x ↘ 8: 10.7x ↘ 9: 10.2x ↘ 10: 10.8x ↘ Series 103.1 618.3

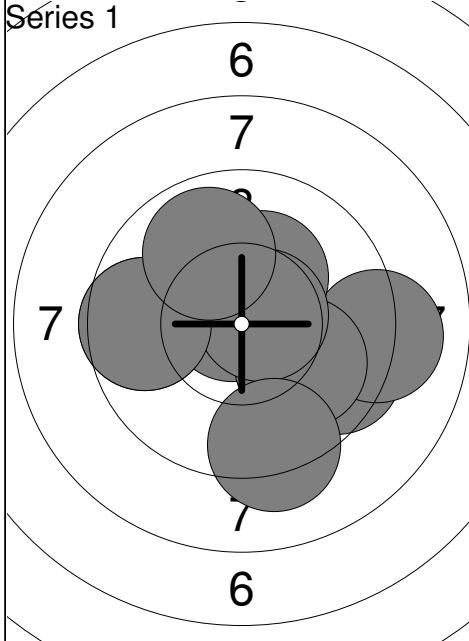

1: 9.6 ←
2: 9.5 →
3: 10.8x ↗
4: 9.1 →
5: 10.0 ↘
6: 10.2x ↗
7: 10.6x →
8: 9.6 ←
9: 9.9 ↗
10: 9.2 ↘
Series 98.5
98.5

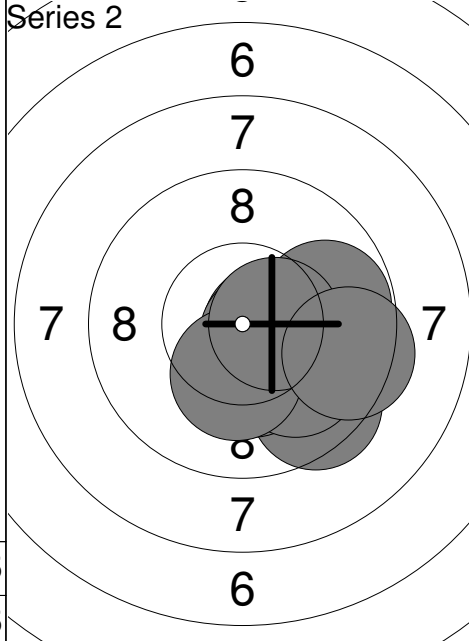

1: 9.5 ↘
2: 10.3x ↘
3: 9.9 →
4: 10.0 ↘
5: 10.6x →
6: 10.6x →
7: 9.8 →
8: 10.2x ↘
9: 10.5x →
10: 9.4 →
Series 100.8
199.3

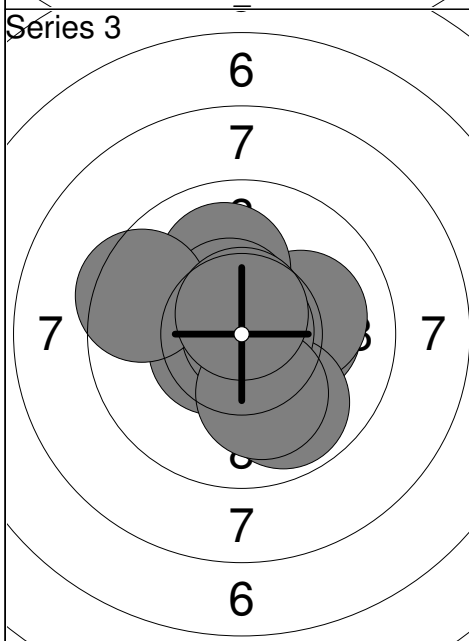

1: 10.2x →
2: 10.1 →
3: 10.0 ↗
4: 10.5x ↗
5: 10.5x ↙
6: 9.8 ↘
7: 10.8x →
8: 10.1 ↘
9: 9.4 ←
10: 10.6x ↗
Series 102.0
301.3

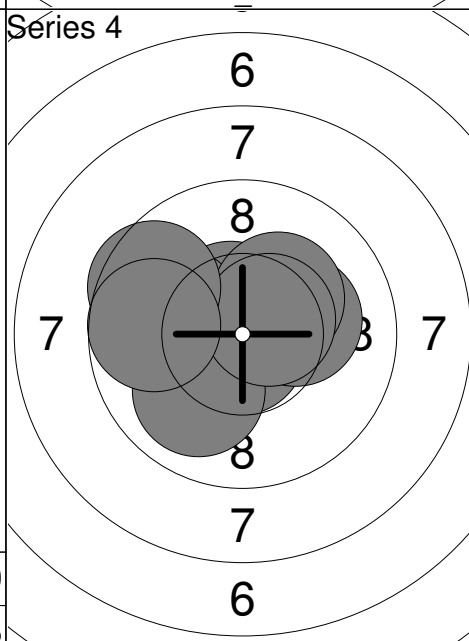

1: 10.7x ↘
2: 10.7x ↙
3: 10.5x ↗
4: 10.2x →
5: 10.0 ←
6: 10.0 ↘
7: 10.2x ↗
8: 10.5x →
9: 9.6 ←
10: 9.7 ←
Series 102.1
403.4

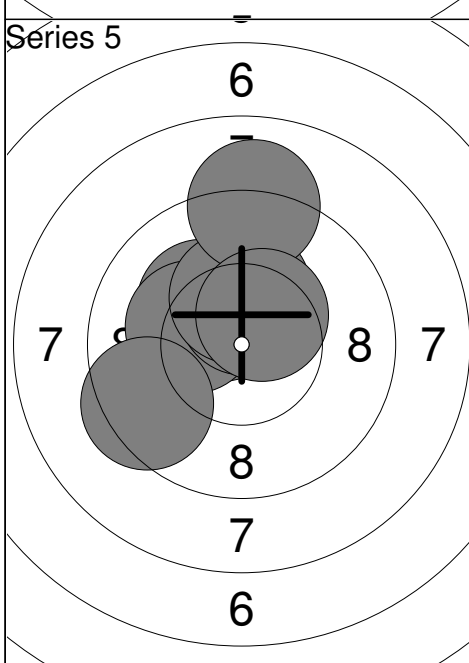

1: 10.2x ↗
2: 10.5x ↗
3: 10.4x ↗
4: 10.2x ↗
5: 10.2x ↙
6: 10.4x ↗
7: 10.3x ↗
8: 9.4 ↙
9: 9.1 ↗
10: 10.4x ↗
Series 101.1
504.5

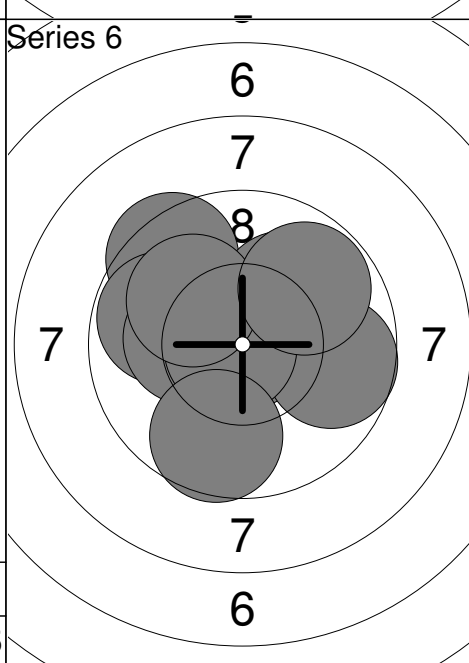

1: 10.9x
2: 9.4 ↗
3: 10.1 ↗
4: 9.7 →
5: 9.8 ←
6: 10.2x ↙
7: 10.7x ↙
8: 10.0 ↗
9: 9.6 ↘
10: 9.8 ↗
Series 100.2
604.7

Relay	Lane	Mira Mäkelä			
1 Air		LappjA	ARW		
17.11.2019		Kankaanpaaopen 17.11	Kankaanpään ampumaurheilijat		
Series 1		1: 10.8x ↙ 2: 10.4x ← 3: 10.2x ↗ 4: 10.7x ← 5: 10.3x → 6: 10.3x → 7: 9.8 ← 8: 10.3x ↗ 9: 10.0 ↓ 10: 10.4x ↗ Series 103.2 103.2	Series 2		1: 10.9x ↗ 2: 9.9 ← 3: 10.4x → 4: 10.6x ↗ 5: 10.6x ← 6: 10.3x ← 7: 10.0 ↓ 8: 10.4x → 9: 8.6 → 10: 10.2x → Series 101.9 205.1
Series 3		1: 10.4x ↗ 2: 10.4x ← 3: 10.5x ← 4: 10.6x ↗ 5: 10.3x ↗ 6: 10.2x → 7: 10.4x ↘ 8: 10.3x ↗ 9: 10.2x ↘ 10: 10.6x → Series 103.9 309.0	Series 4		1: 10.4x ← 2: 10.1 ↓ 3: 10.6x → 4: 10.1 ← 5: 9.9 ↗ 6: 10.3x ↗ 7: 10.5x ↗ 8: 10.5x ↗ 9: 10.5x ← 10: 10.6x ↗ Series 103.5 412.5
Series 5		1: 10.0 ↙ 2: 9.9 ↗ 3: 10.7x ↘ 4: 10.1 ↗ 5: 9.9 ↗ 6: 9.6 ↗ 7: 9.9 ↗ 8: 10.0 → 9: 10.6x → 10: 10.8x ← Series 101.5 514.0	Series 6		1: 9.9 ↘ 2: 10.8x → 3: 10.6x ↓ 4: 10.2x ↓ 5: 10.1 → 6: 10.3x → 7: 10.3x ← 8: 10.7x ↙ 9: 10.5x ← 10: 10.7x ↗ Series 104.1 618.1

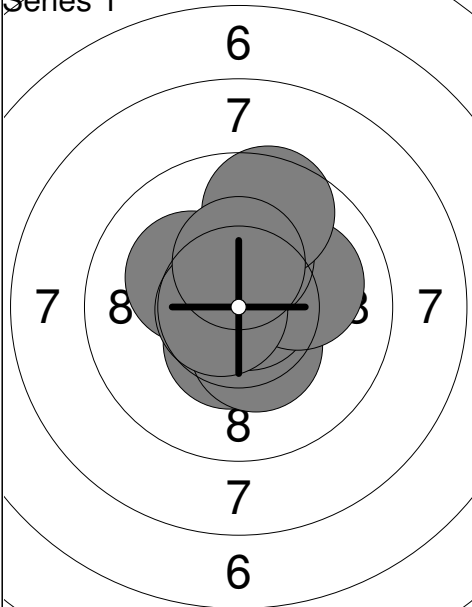
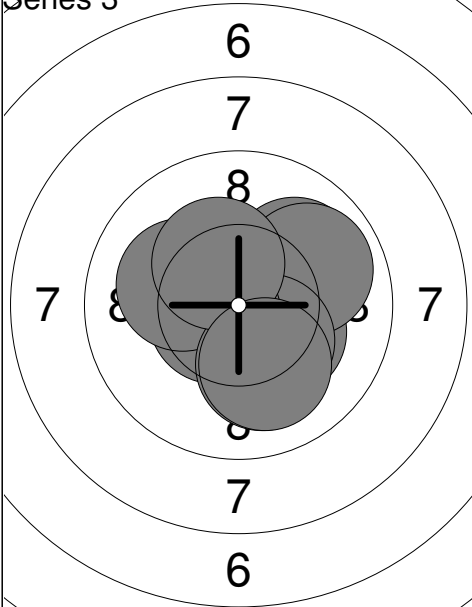
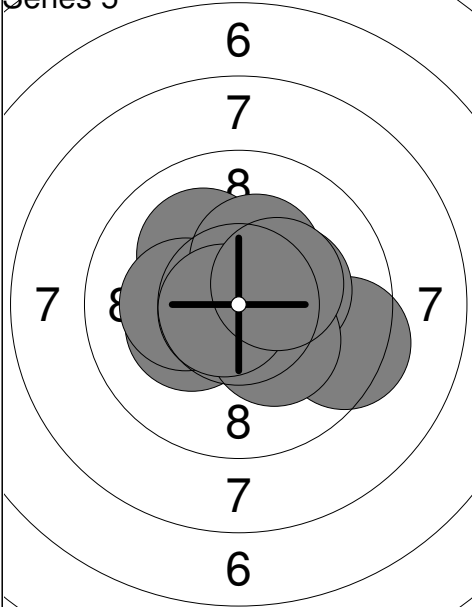
Relay	Lane	Julia Rannikko	
1 Air	16	SaSA	ARW
17.11.2019	Kankaanpaaopen 17.11	Kankaanpään ampumaurheilijat	
Series 1		1: 10.8x ↙ 2: 10.4x ↓ 3: 10.4x ↓ 4: 10.8x → 5: 10.0 → 6: 10.2x ↑ 7: 10.2x ↖ 8: 10.7x ← 9: 9.6 ↑ 10: 10.3x ↑	Series 2
		Series 103.4	Series 103.9
		103.4	207.3
Series 3		1: 10.3x ↘ 2: 10.6x ↑ 3: 10.0 → 4: 9.9 → 5: 10.3x ↓ 6: 10.6x ↖ 7: 10.1 ← 8: 10.1 ↓ 9: 10.3x ↑ 10: 10.0 ↓	Series 4
		Series 102.2	Series 104.3
		309.5	413.8
Series 5		1: 10.1 ↖ 2: 10.2x ↖ 3: 9.4 → 4: 10.5x → 5: 10.3x → 6: 10.3x ↓ 7: 10.2x ← 8: 10.3x ↑ 9: 10.7x ← 10: 10.3x →	Series 6
		Series 102.3	Series 103.7
		516.1	619.8

Relay	Lane	Saana Peltonen	
1	17		
1 Air		KeuSA	ARW
17.11.2019		Kankaanpaaopen 17.11	Kankaanpään ampumaurheilijat
Series 1		Series 2	
	1: 10.4x ↘ 2: 9.6 ↗ 3: 9.6 ↘ 4: 10.6x ↗ 5: 9.9 ↗ 6: 10.6x ↘ 7: 9.7 ↗ 8: 10.1 ↘ 9: 10.6x ← 10: 9.9 ↖		1: 10.3x ↗ 2: 10.0 ↗ 3: 9.7 → 4: 10.1 ↘ 5: 10.8x ↘ 6: 10.4x ↖ 7: 9.9 ↗ 8: 10.0 → 9: 10.9x 10: 10.8x →
Series	101.0	Series	102.9
	101.0		203.9
Series 3		Series 4	
	1: 9.1 → 2: 10.5x → 3: 9.6 → 4: 10.6x ← 5: 10.0 ↗ 6: 10.0 → 7: 10.5x ← 8: 10.2x ↗ 9: 10.1 ← 10: 10.2x ↘		1: 10.8x ↗ 2: 10.5x ↘ 3: 10.4x ← 4: 10.1 ↖ 5: 9.9 ↗ 6: 9.5 → 7: 10.6x ↖ 8: 10.6x → 9: 9.9 → 10: 10.2x ←
Series	100.8	Series	102.5
	304.7		407.2
Series 5		Series 6	
	1: 9.9 ↗ 2: 10.9x ↖ 3: 10.8x ↗ 4: 10.1 ↗ 5: 10.2x ← 6: 10.7x ↘ 7: 10.3x ↗ 8: 10.2x ↗ 9: 10.0 ↖ 10: 10.4x ↗		1: 10.3x ↗ 2: 10.3x ↗ 3: 9.2 ← 4: 10.2x ↗ 5: 9.9 ← 6: 10.4x ← 7: 10.4x ↖ 8: 10.4x ← 9: 10.3x ↗ 10: 10.6x ←
Series	103.5	Series	102.0
	510.7		612.7