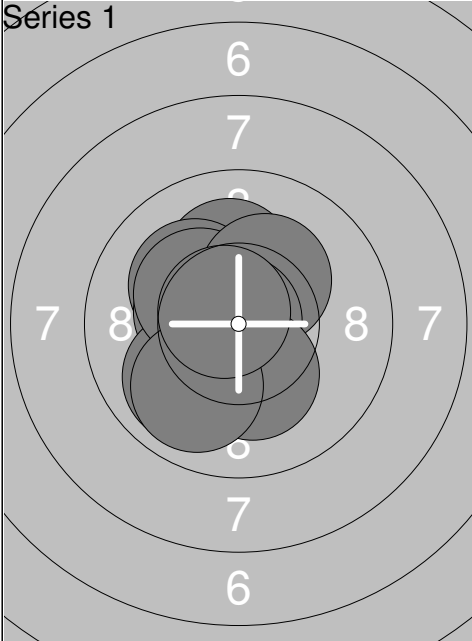
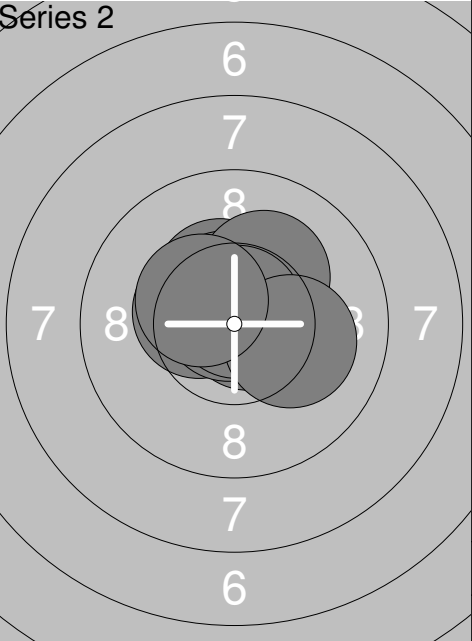
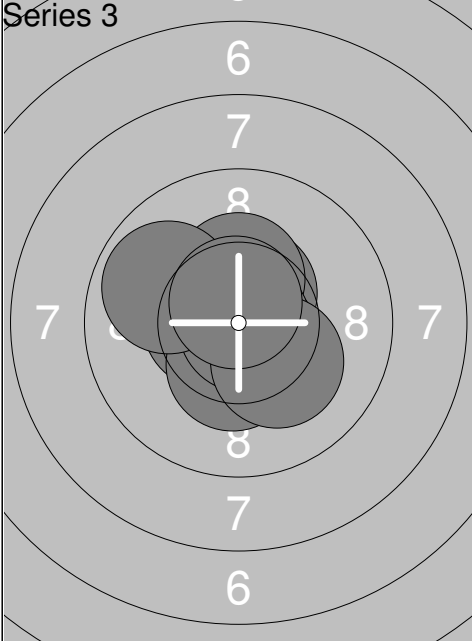
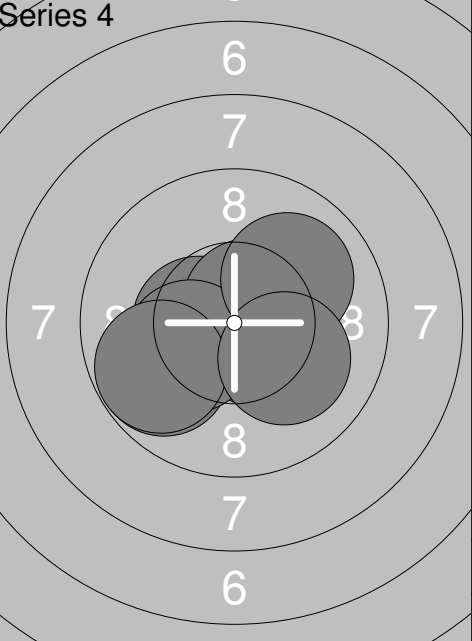
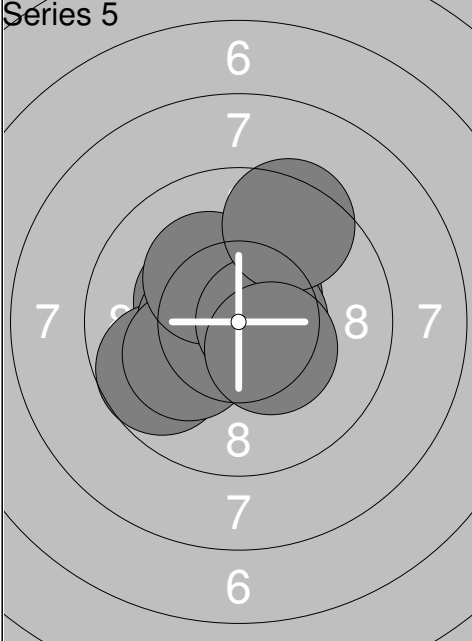
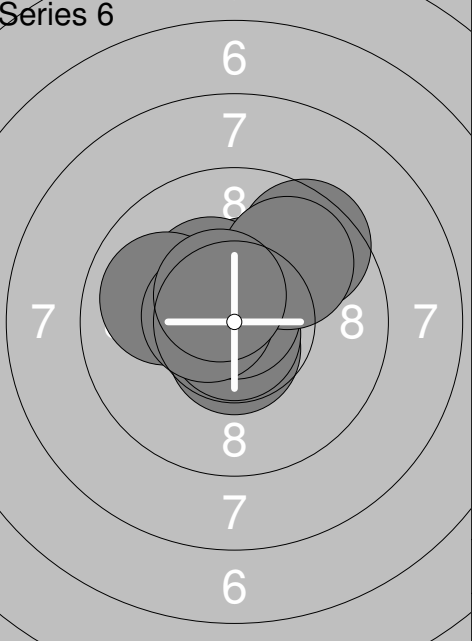

Relay	Lane	Juho Kurki	
1 Air		KaA	ARM
16.11.2019		Kankaanpaaopen 16.11	Kankaanpään ampumaurheilijat
Series 1		1: 10.1 ↑ 2: 10.1 ↘ 3: 10.4x ↙ 4: 9.9 ↘ 5: 10.3x ↘ 6: 10.2x ↗ 7: 10.9x ↘ 8: 10.2x ↓ 9: 9.9 ↘ 10: 10.7x ↘ Series 102.7 102.7	Series 2  1: 10.5x → 2: 10.7x → 3: 10.4x ↗ 4: 10.4x ↙ 5: 10.6x ↑ 6: 10.8x ↘ 7: 10.2x ↗ 8: 10.8x ↑ 9: 10.1 → 10: 10.4x ↘ Series 104.9 207.6
Series 3		1: 10.5x ← 2: 10.8x ↓ 3: 10.5x ↗ 4: 10.3x ↑ 5: 10.6x ↘ 6: 10.4x ↓ 7: 10.8x → 8: 10.2x ↘ 9: 9.9 ← 10: 10.6x ↑ Series 104.6 312.2	Series 4  1: 10.9x ← 2: 10.8x ↗ 3: 10.5x ↘ 4: 10.4x ← 5: 10.6x ↗ 6: 9.8 ← 7: 10.2x ← 8: 10.0 ↗ 9: 9.8 ← 10: 10.1 ↘ Series 103.1 415.3
Series 5		1: 10.3x ↘ 2: 10.8x ↘ 3: 9.7 ← 4: 10.5x ↗ 5: 10.4x ← 6: 10.1 ← 7: 10.2x ↘ 8: 10.6x → 9: 9.4 ↗ 10: 10.4x ↘ Series 102.4 517.7	Series 6  1: 10.4x ↑ 2: 10.3x ↘ 3: 10.6x ↓ 4: 10.8x ↓ 5: 10.8x ↑ 6: 9.5 ↗ 7: 10.0 ← 8: 10.6x ← 9: 9.9 ↗ 10: 10.5x ↘ Series 103.4 621.1

<b>Series 1</b> 	1: 10.6x ↗	<b>Series 2</b> 	1: 10.7x ↘
	2: 10.1 ↑		2: 10.6x ↗
	3: 10.5x ↗		3: 10.4x ↘
	4: 10.8x ↑		4: 10.5x ↗
	5: 10.7x ←		5: 10.7x ↗
	6: 10.6x ↗		6: 10.3x ↑
	7: 10.7x ↓		7: 10.3x ↓
	8: 10.7x ↓		8: 10.5x ↓
	9: 10.5x ↘		9: 10.4x ↘
	10: 10.2x ↘		10: 10.8x ↘
	<b>Series 105.4</b>		<b>Series 105.2</b>
	<b>105.4</b>		<b>210.6</b>

<b>Series 3</b> 	1: 10.3x ↘	<b>Series 4</b> 	1: 10.5x ↘
	2: 9.9 ↓		2: 10.4x ↓
	3: 10.7x ↗		3: 10.3x ↘
	4: 10.4x ↗		4: 10.3x ←
	5: 10.5x ↗		5: 10.8x ↗
	6: 10.6x →		6: 10.7x ↑
	7: 10.3x ←		7: 10.7x ←
	8: 10.4x ↗		8: 10.2x ↘
	9: 10.4x ↑		9: 10.9x
	10: 10.8x ↘		10: 10.5x ↘
	<b>Series 104.3</b>		<b>Series 105.3</b>
	<b>314.9</b>		<b>420.2</b>

<b>Series 5</b> 	1: 10.6x ↗	<b>Series 6</b> 	1: 10.8x ↑
	2: 10.4x ↗		2: 10.3x ↘
	3: 10.5x →		3: 10.0 ←
	4: 9.6 →		4: 10.7x ↗
	5: 10.7x ↓		5: 10.1 ↘
	6: 10.5x ↘		6: 10.4x ↓
	7: 10.7x ↓		7: 10.4x ←
	8: 10.2x ↘		8: 10.6x ↓
	9: 10.5x ↑		9: 10.2x ↗
	10: 10.1 ↓		10: 9.8 →
	<b>Series 103.8</b>		<b>Series 103.3</b>
	<b>524.0</b>		<b>627.3</b>

Relay <b>1</b>	Lane <b>20</b>	<b>Jimi Lång</b>
-------------------	-------------------	------------------

1 Air	KaA	ARM
-------	-----	-----

16.11.2019	Kankaanpaaopen 16.11	Kankaanpään ampumaurheilijat
------------	----------------------	------------------------------

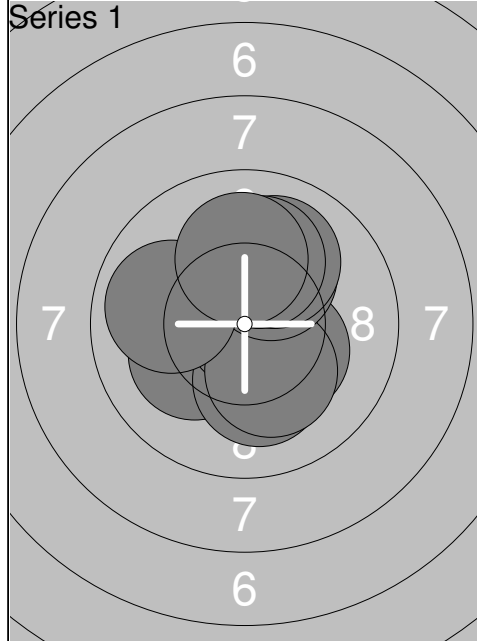

1:	10.1	↙
2:	10.1	↓
3:	10.3x	↘
4:	10.9x	→
5:	10.2x	↘
6:	10.2x	↗
7:	9.9	←
8:	10.0	↗
9:	10.1	↑
10:	10.1	↑
Series	101.9	
	101.9	

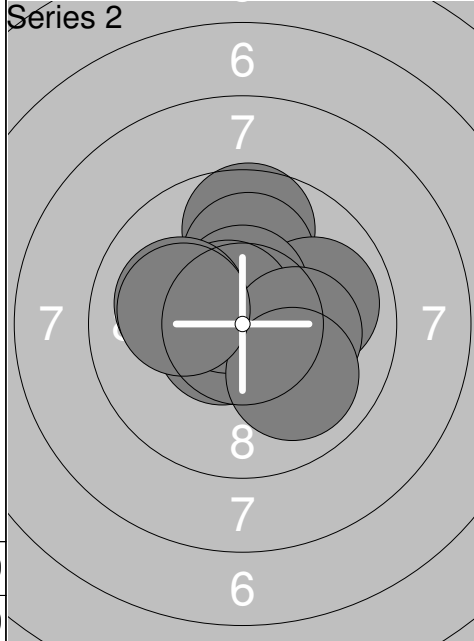

1:	10.6x	↙
2:	9.7	↑
3:	10.0	↑
4:	9.9	→
5:	10.5x	↑
6:	10.6x	↖
7:	10.2x	→
8:	10.0	↘
9:	10.1	←
10:	10.1	←
Series	101.7	
	203.6	

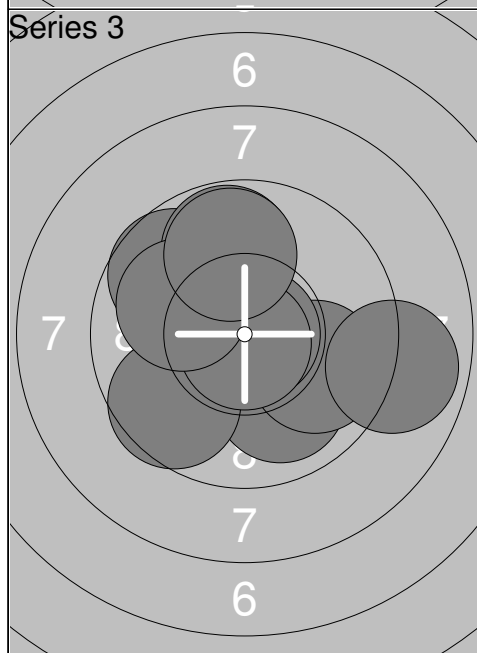

1:	9.7	↖
2:	10.0	↓
3:	9.6	↖
4:	9.8	↑
5:	9.9	↘
6:	8.9	→
7:	10.8x	→
8:	10.8x	↓
9:	10.0	←
10:	9.8	↑
Series	99.3	
	302.9	

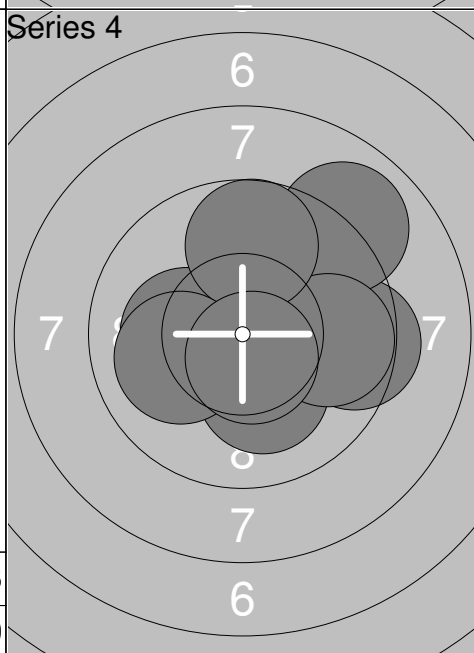

1:	10.8x	↙
2:	10.2x	→
3:	10.2x	←
4:	10.2x	↓
5:	9.4	→
6:	8.9	↗
7:	9.8	→
8:	9.7	↑
9:	10.0	←
10:	10.6x	↓
Series	99.8	
	402.7	

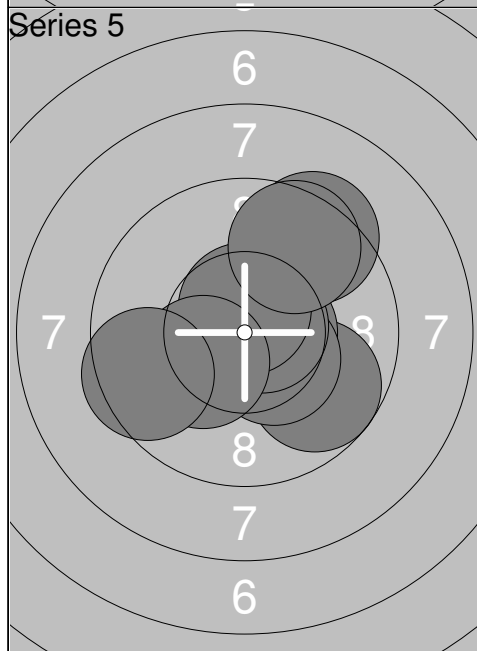

1:	10.9x	
2:	9.7	↘
3:	10.6x	→
4:	10.4x	↘
5:	10.7x	→
6:	9.3	↗
7:	10.6x	↑
8:	9.6	↗
9:	10.2x	↙
10:	9.5	←
Series	101.5	
	504.2	

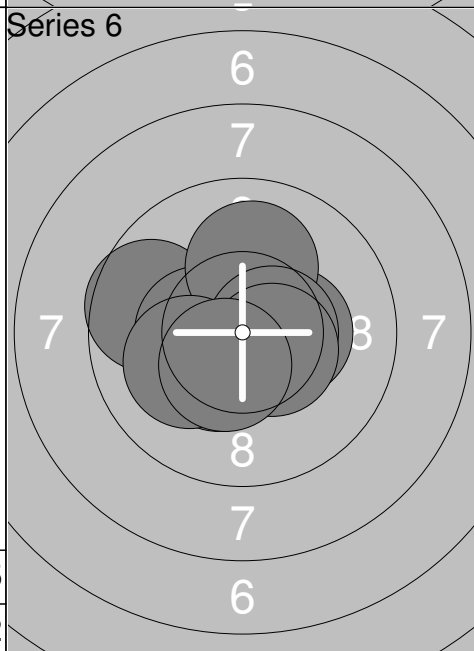

1:	10.4x	↙
2:	9.6	←
3:	10.3x	→
4:	10.6x	↓
5:	10.4x	←
6:	10.0	↑
7:	10.5x	→
8:	10.5x	↘
9:	10.1	←
10:	10.4x	↙
Series	102.8	
	607.0	

Relay	Lane	Joni Stenström		
1 Air		RS	ARM	
16.11.2019		Kankaanpaaopen 16.11	Kankaanpään ampumaurheilijat	
Series 1		1: 9.5 ← 2: 10.5x ↘ 3: 10.8x ↗ 4: 10.5x ← 5: 10.4x ↗ 6: 10.1 ↖ 7: 10.7x ↑ 8: 10.4x ← 9: 10.5x ↙ 10: 9.9 ← Series 103.3 103.3	Series 2 	1: 10.1 → 2: 10.4x ↖ 3: 10.0 ↓ 4: 10.2x ↑ 5: 9.5 ← 6: 10.6x ↖ 7: 10.3x ↗ 8: 10.1 ← 9: 10.7x ↗ 10: 10.7x ← Series 102.6 205.9
Series 3		1: 10.7x ↑ 2: 10.8x ← 3: 10.3x → 4: 10.7x ↓ 5: 9.7 ← 6: 10.4x ↓ 7: 10.6x ↗ 8: 10.8x ↖ 9: 10.6x ← 10: 10.3x ↖ Series 104.9 310.8	Series 4 	1: 10.3x ← 2: 10.6x ↗ 3: 10.6x ↘ 4: 10.4x ← 5: 10.8x ↗ 6: 10.5x ← 7: 10.4x ↘ 8: 10.8x ↓ 9: 10.9x ↘ 10: 10.3x ← Series 105.6 416.4
Series 5		1: 10.6x ↘ 2: 9.8 ↗ 3: 10.4x ← 4: 10.8x ↓ 5: 10.7x → 6: 10.0 ↗ 7: 10.2x ↗ 8: 10.1 ↓ 9: 10.5x ← 10: 10.3x ↑ Series 103.4 519.8	Series 6 	1: 10.5x ↓ 2: 10.5x → 3: 10.1 → 4: 9.7 ↖ 5: 10.4x ← 6: 10.2x ↓ 7: 10.3x ↖ 8: 10.2x ← 9: 10.7x ↗ 10: 10.4x ↘ Series 103.0 622.8

Relay	Lane	Marko Kangas				
1 Air	22	IMAS	ARM			
16.11.2019	Kankaanpaaopen 16.11	Kankaanpään ampumaurheilijat				
Series 1		1: 10.5x ← 2: 9.4 ← 3: 10.5x ↗ 4: 8.3 → 5: 10.0 ← 6: 9.2 ← 7: 8.8 ↓ 8: 10.4x → 9: 9.9 ↓ 10: 10.3x ↘	Series 2		1: 10.3x ↗ 2: 8.4 ← 3: 9.8 ↓ 4: 9.7 ↗ 5: 10.2x ↘ 6: 9.5 ← 7: 8.5 ← 8: 10.4x → 9: 10.1 ↘ 10: 10.6x ↗	Series 97.3 97.3 Series 97.5 194.8
Series 3		1: 10.2x ↘ 2: 8.5 ← 3: 9.0 ← 4: 7.9 ← 5: 10.0 ↓ 6: 10.0 ← 7: 10.0 → 8: 9.7 ↓ 9: 10.3x ↘ 10: 10.3x ↙	Series 4		1: 10.6x ↙ 2: 10.7x ↗ 3: 8.7 ↘ 4: 9.4 ↖ 5: 10.0 ← 6: 9.9 ← 7: 9.1 → 8: 9.9 ← 9: 10.8x → 10: 9.3 ↓	Series 95.9 290.7 Series 98.4 389.1
Series 5		1: 10.7x ↘ 2: 9.9 ← 3: 10.5x ↗ 4: 9.8 ↗ 5: 9.8 ↗ 6: 10.0 → 7: 9.4 ↓ 8: 10.0 ↘ 9: 10.3x ↘ 10: 10.6x →	Series 6		1: 9.4 ↓ 2: 10.0 ← 3: 9.5 ← 4: 8.7 → 5: 9.9 ↘ 6: 8.0 ↘ 7: 10.2x ↙ 8: 9.7 ↗ 9: 9.5 ↑ 10: 9.7 ↓	Series 101.0 490.1 Series 94.6 584.7

Relay	Lane	Albin Johansson		
1 Air	23	SWE	ARM	
16.11.2019	Kankaanpaaopen 16.11	Kankaanpään ampumaurheilijat		
<b>Series 1</b> 	1: 10.5x ↗	<b>Series 2</b> 	1: 10.1 ↘	
	2: 9.8 ↙		2: 9.8 ↗	
	3: 10.4x ↘		3: 9.7 ↙	
	4: 9.9 ↘		4: 10.2x ↘	
	5: 9.9 ↙		5: 10.2x ↘	
	6: 9.0 →		6: 9.6 ↗	
	7: 10.3x ↑		7: 10.1 ↙	
	8: 9.7 ↘		8: 10.6x ↗	
	9: 10.4x ↗		9: 10.6x ↘	
	10: 10.2x →		10: 9.8 →	
	<b>Series</b> 100.1		<b>Series</b> 100.7	
	100.1		200.8	
<b>Series 3</b> 	1: 10.6x ↑	<b>Series 4</b> 	1: 9.6 ↘	
	2: 10.3x ↑		2: 10.1 ↘	
	3: 9.9 →		3: 10.2x ↘	
	4: 10.5x ↙		4: 10.5x →	
	5: 9.4 →		5: 9.2 ↙	
	6: 10.1 ↙		6: 9.9 →	
	7: 10.2x →		7: 10.1 ↑	
	8: 9.2 ↘		8: 9.0 ↗	
	9: 9.4 ↗		9: 9.6 ↗	
	10: 9.9 →		10: 10.6x ↘	
	<b>Series</b> 99.5		<b>Series</b> 98.8	
	300.3		399.1	
<b>Series 5</b> 	1: 10.0 ↘	<b>Series 6</b> 	1: 10.6x ↑	
	2: 10.5x ↙		2: 10.6x ↘	
	3: 10.3x ↘		3: 10.9x ↑	
	4: 10.8x ↑		4: 10.1 ↙	
	5: 10.1 →		5: 10.5x ↗	
	6: 10.5x ↘		6: 10.2x →	
	7: 9.9 →		7: 10.2x →	
	8: 9.7 →		8: 10.6x ↙	
	9: 10.0 ↗		9: 9.4 ↑	
	10: 10.3x ↙		10: 10.2x ↗	
	<b>Series</b> 102.1		<b>Series</b> 103.3	
	501.2		604.5	

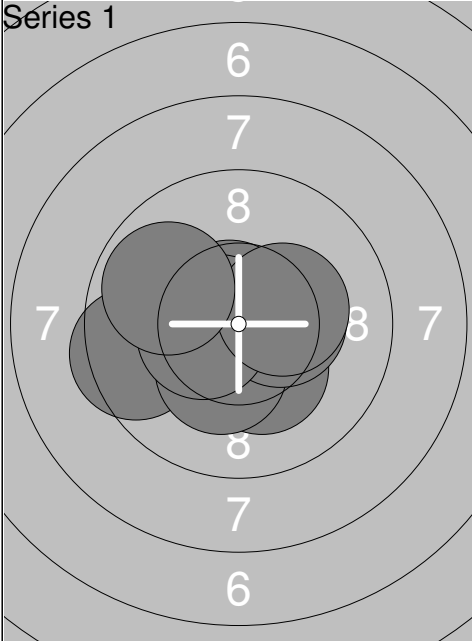
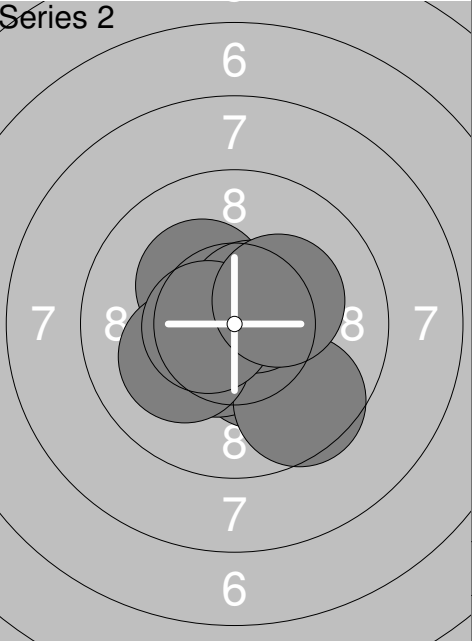
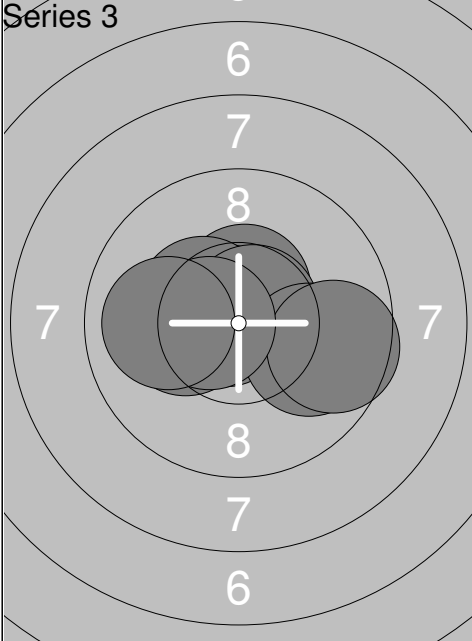
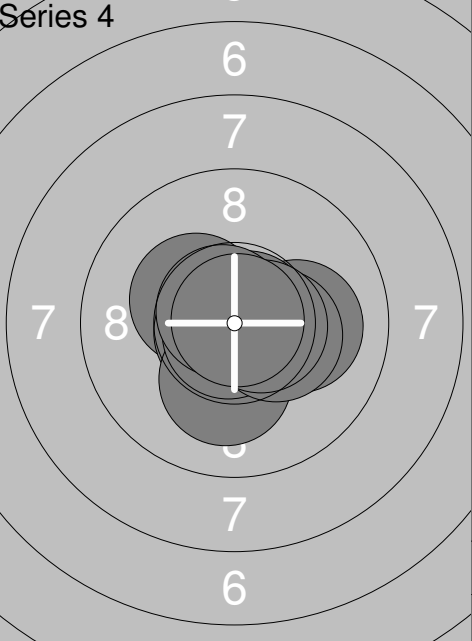
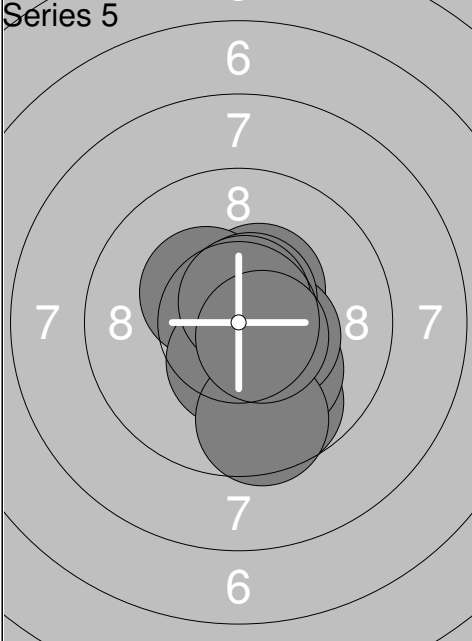
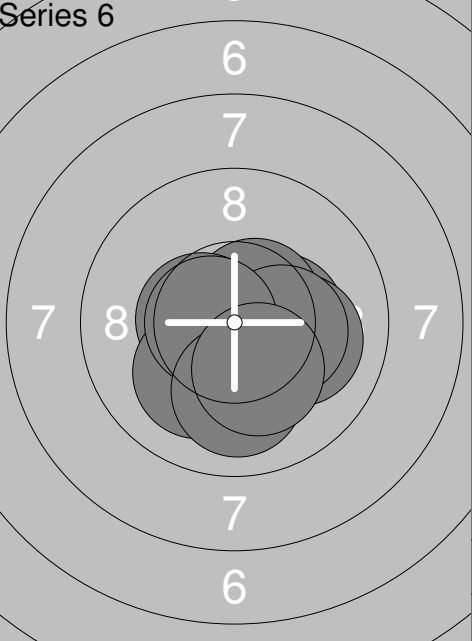
Relay	Lane	Name		
1	24	Marcus Madsen		
1 Air	SWE	ARM		
16.11.2019	Kankaanpaaopen 16.11	Kankaanpään ampumaurheilijat		
Series 1		1: 10.8x ↘ 2: 10.6x ↗ 3: 10.6x ← 4: 9.5 ← 5: 10.2x ↘ 6: 10.3x ↘ 7: 10.4x → 8: 10.4x ← 9: 10.3x → 10: 9.8 ← Series 102.9 102.9	Series 2 	1: 10.6x ↗ 2: 10.3x ↗ 3: 10.7x ↓ 4: 10.3x ↘ 5: 10.5x ↘ 6: 9.5 ↘ 7: 10.1 ← 8: 10.6x ↗ 9: 10.6x ← 10: 10.2x ↗ Series 103.4 206.3
Series 3		1: 10.5x ↑ 2: 10.7x ← 3: 10.7x ↗ 4: 10.4x ↗ 5: 10.2x ← 6: 10.7x ↗ 7: 9.9 → 8: 9.6 → 9: 10.5x ← 10: 10.0 ← Series 103.2 309.5	Series 4 	1: 10.3x ↗ 2: 10.1 → 3: 10.7x ← 4: 10.1 ↓ 5: 10.8x ↘ 6: 10.8x ↗ 7: 10.4x → 8: 10.7x ↗ 9: 10.6x → 10: 10.9x ↗ Series 105.4 414.9
Series 5		1: 10.4x ↗ 2: 9.7 ↓ 3: 10.1 ↓ 4: 10.4x → 5: 10.3x ↗ 6: 10.6x ↗ 7: 10.4x ↓ 8: 9.6 ↓ 9: 10.6x ↑ 10: 10.5x ↘ Series 102.6 517.5	Series 6 	1: 10.3x → 2: 10.1 → 3: 10.6x ↗ 4: 10.4x ↓ 5: 10.5x ← 6: 10.3x → 7: 10.1 ↓ 8: 10.6x ← 9: 10.0 ↓ 10: 10.2x ↘ Series 103.1 620.6

Relay	Lane	Jere-Juhani Salo		
1 Air		NoSA	ARM	
16.11.2019		Kankaanpaaopen 16.11	Kankaanpään ampumaurheilijat	
Series 1 	1: 10.5x ↘	Series 2 	1: 10.8x ↘	
	2: 10.5x →		2: 10.8x ↙	
	3: 9.2 ↗		3: 10.3x ↙	
	4: 10.3x ↙		4: 10.7x ↗	
	5: 9.9 ↗		5: 10.1 →	
	6: 10.7x ↙		6: 10.3x ↗	
	7: 10.6x ↗		7: 10.7x ↙	
	8: 9.4 ←		8: 9.5 ↗	
	9: 9.4 ←		9: 9.1 ↙	
	10: 10.5x ↘		10: 10.3x →	
	Series 101.0		Series 102.6	
	101.0		203.6	
Series 3 	1: 10.0 ↗	Series 4 	1: 9.5 ↗	
	2: 10.5x ↗		2: 10.0 ↙	
	3: 10.0 ↙		3: 10.4x ↗	
	4: 10.4x →		4: 10.1 ←	
	5: 10.4x ↘		5: 10.2x ↗	
	6: 10.3x ↙		6: 9.7 ←	
	7: 10.7x ↗		7: 10.2x ↘	
	8: 9.9 ↗		8: 10.0 ↗	
	9: 10.0 ↘		9: 10.6x →	
	10: 10.2x ↙		10: 10.3x →	
	Series 102.4		Series 101.0	
	306.0		407.0	
Series 5 	1: 10.9x ↗	Series 6 	1: 9.5 ↙	
	2: 9.9 →		2: 10.7x →	
	3: 10.5x ↙		3: 10.8x ↙	
	4: 10.0 ←		4: 10.6x ↗	
	5: 9.8 →		5: 10.6x ↗	
	6: 10.8x ↙		6: 9.9 ↗	
	7: 9.0 ↗		7: 10.4x ↘	
	8: 9.3 ↗		8: 9.6 ↘	
	9: 9.3 ↘		9: 10.6x ↗	
	10: 9.5 ←		10: 10.6x ↙	
	Series 99.0		Series 103.3	
	506.0		609.3	