

Relay	Lane	Sebastian Långström				
Air	KSF	ARJM				
19.11.2017	Superfinaali	Kankaanpään Ampumaurheilijat				
Series 1		1: 10.1 ↓	Series 2	Series 2		1: 10.4x ↗
		2: 10.5x ↗			2: 10.3x ↘	
		3: 9.9 ↙			3: 10.6x ↗	
		4: 10.4x ↓		4: 10.6x ↑		4: 10.6x ↓
		5: 10.5x ↑		5: 10.2x ↘		5: 10.5x ↑
		6: 10.6x ↑		6: 10.5x ↑		6: 10.2x ↘
		7: 10.6x ↑		7: 10.2x ↘		7: 10.6x ↑
		8: 9.9 ↓		8: 10.6x ↑		8: 10.7x ↑
		9: 10.4x ↗		9: 10.7x ↑		9: 10.1 ↓
		10: 10.4x ↓		10: 10.1 ↓		10: 10.4x ↓
	Series	103.3		Series	104.2	
		103.3			207.5	
Series 3		1: 10.3x ↓	Series 4	Series 4		1: 9.9 ↙
		2: 10.3x ↗			2: 9.7 ↓	
		3: 10.5x ↑			3: 10.4x ↗	
		4: 10.5x ↑		4: 10.4x ↓		4: 10.4x ↓
		5: 9.6 ↓		5: 10.0 ↓		5: 10.0 ↓
		6: 10.4x ↘		6: 10.7x ↑		6: 10.7x ↑
		7: 10.5x ↑		7: 9.8 ↓		7: 9.8 ↓
		8: 10.3x ↓		8: 10.9x ↑		8: 10.9x ↑
		9: 10.7x ↑		9: 10.2x ↗		9: 10.2x ↗
		10: 10.3x ↓		10: 10.6x ↑		10: 10.6x ↑
	Series	103.4		Series	102.6	
		310.9			413.5	
Series 5		1: 10.4x ↗	Series 6	Series 6		1: 10.7x ↗
		2: 10.0 ↗			2: 10.2x ↘	
		3: 10.0 ↘			3: 10.8x ↑	
		4: 10.4x ↑		4: 10.5x ↓		4: 10.5x ↓
		5: 10.7x ↑		5: 10.6x ↑		5: 10.6x ↑
		6: 10.6x ↑		6: 9.8 ↓		6: 9.8 ↓
		7: 9.7 ↗		7: 10.1 ↑		7: 10.1 ↑
		8: 10.0 ↓		8: 10.4x ↗		8: 10.4x ↗
		9: 10.5x ↑		9: 9.7 →		9: 9.7 →
		10: 10.5x ↘		10: 9.5 ↓		10: 9.5 ↓
	Series	102.8		Series	102.3	
		516.3			618.6	

Relay	Lane	Niko Elonen	
Air	KaA	ARJM	
19.11.2017	Superfinaali	Kankaanpään Ampumaurheilijat	
Series 1		1: 9.4 ↗ 2: 9.8 ↗ 3: 8.5 ← 4: 8.4 ← 5: 7.8 ⇒ 6: 9.1 ⇒ 7: 10.1 ↗ 8: 10.0 ⇒ 9: 9.5 ← 10: 9.7 ↗	Series 92.3
			92.3
Series 2		1: 9.0 ↑ 2: 8.6 ↗ 3: 8.6 ↖ 4: 9.3 ↑ 5: 7.7 ← 6: 8.0 ↑ 7: 8.0 ⇒ 8: 9.7 ↑ 9: 9.9 ↗ 10: 10.1 ←	Series 88.9
			181.2
Series 3		1: 8.8 ↗ 2: 9.8 ↘ 3: 9.9 ← 4: 10.4x ⇒ 5: 10.4x ↘ 6: 9.0 ← 7: 10.4x ↑ 8: 8.9 ← 9: 10.1 ← 10: 7.9 ↘	Series 95.6
			276.8
Series 4		1: 7.8 ↖ 2: 7.6 ← 3: 8.1 ↑ 4: 9.2 ↖ 5: 9.3 ⇒ 6: 10.4x ↗ 7: 9.4 ↑ 8: 9.7 ↖ 9: 6.8 ↖ 10: 8.8 ↗	Series 87.1
			363.9
Series 5		1: 8.4 ↖ 2: 9.6 ↑ 3: 10.1 ↗ 4: 8.0 ← 5: 9.0 ↑ 6: 9.4 ↖ 7: 10.5x ↗ 8: 8.4 ↗ 9: 9.0 ↘ 10: 10.2x ↖	Series 92.6
			456.5
Series 6		1: 10.3x ↗ 2: 7.3 ↖ 3: 8.8 ⇒ 4: 10.1 ↗ 5: 7.9 ↗ 6: 9.5 ↑ 7: 7.5 ↗ 8: 8.6 ← 9: 10.1 ↗ 10: 9.3 ⇒	Series 89.4
			545.9

Relay	Lane	Jere-Juhani Salo			
Air	NoSA	ARJM			
19.11.2017	Superfinaali	Kankaanpään Ampumaurheilijat			
Series 1		1: 10.7x↗	Series 2		1: 10.5x➤
		2: 10.0↙			2: 10.6x↗
		3: 10.7x↗			3: 10.0➤
		4: 10.8x➤		4: 9.8 ↙	
		5: 9.5 ↗		5: 10.3x↗	
		6: 9.6 ➤		6: 10.5x↗	
		7: 9.8 ↙		7: 9.9 ➤	
		8: 9.9 ↗		8: 10.9x↗	
		9: 10.4x↗		9: 10.7x↗	
		10: 9.5 ↙		10: 10.6x↗	
	Series	100.9		Series	103.8
		100.9			204.7
Series 3		1: 10.6x↗	Series 4		1: 10.4x↙
		2: 10.6x➤			2: 10.5x↗
		3: 10.5x↗			3: 10.3x↙
		4: 10.0 ➤		4: 10.6x↗	
		5: 10.2x➤		5: 10.7x↗	
		6: 10.0 ➤		6: 10.3x↗	
		7: 10.3x↙		7: 10.6x↗	
		8: 10.5x↗		8: 10.7x↗	
		9: 9.6 ↙		9: 10.5x↗	
		10: 10.5x➤		10: 9.7 ➤	
	Series	102.8		Series	104.3
		307.5			411.8
Series 5		1: 10.2x↙	Series 6		1: 10.8x↗
		2: 10.4x↗			2: 8.8 ➤
		3: 10.7x↗			3: 9.7 ➤
		4: 10.6x↗		4: 10.0 ↙	
		5: 10.5x↙		5: 10.4x↙	
		6: 10.4x↗		6: 10.6x↗	
		7: 10.3x↗		7: 10.6x➤	
		8: 10.8x➤		8: 9.9 ↗	
		9: 10.1 ↙		9: 10.3x↗	
		10: 10.3x↙		10: 10.5x↙	
	Series	104.3		Series	101.6
		516.1			617.7

Relay	Lane	Matias Kiuru				
Air	PAS	ARJM				
19.11.2017	Superfinaali	Kankaanpään Ampumaurheilijat				
Series 1		1: 10.1 ↗	Series 2	Series 2		1: 10.7x↗
		2: 10.6x↗			2: 10.7x↗	
		3: 10.3x➤			3: 10.7x➤	
		4: 10.2x↘		4: 10.3x↘		
		5: 10.9x↗		5: 10.7x↗		
		6: 10.6x↗		6: 10.6x↗		
		7: 10.0 ↗		7: 10.3x↘		
		8: 10.0 ↘		8: 10.5x↘		
		9: 10.3x↘		9: 9.8 ➤		
		10: 10.4x↘		10: 10.3x↘		
	Series 103.4		Series 104.6			
	103.4		208.0			
Series 3		1: 9.8 ↘	Series 4	Series 4		1: 10.1 ↘
		2: 9.9 ↗			2: 9.9 ↗	
		3: 10.2x↗			3: 10.8x➤	
		4: 9.9 ↗		4: 10.5x↗		
		5: 10.7x↗		5: 9.5 ↖		
		6: 10.8x➤		6: 10.2x↗		
		7: 10.8x➤		7: 9.7 ↖		
		8: 10.0 ↖		8: 10.6x↗		
		9: 10.5x↘		9: 9.7 ➤		
		10: 10.6x↗		10: 10.8x➤		
	Series 103.2		Series 101.8			
	311.2		413.0			
Series 5		1: 10.4x↘	Series 6	Series 6		1: 9.8 ↘
		2: 10.7x➤			2: 9.1 ↖	
		3: 10.2x➤			3: 9.7 ↗	
		4: 10.7x➤		4: 10.5x↗		
		5: 10.6x➤		5: 10.4x↗		
		6: 10.5x↗		6: 10.4x↘		
		7: 10.1 ↙		7: 9.7 ➤		
		8: 10.3x↘		8: 9.9 ↘		
		9: 10.3x↘		9: 10.1 ↗		
		10: 10.3x➤		10: 10.2x↘		
	Series 104.1		Series 99.8			
	517.1		616.9			

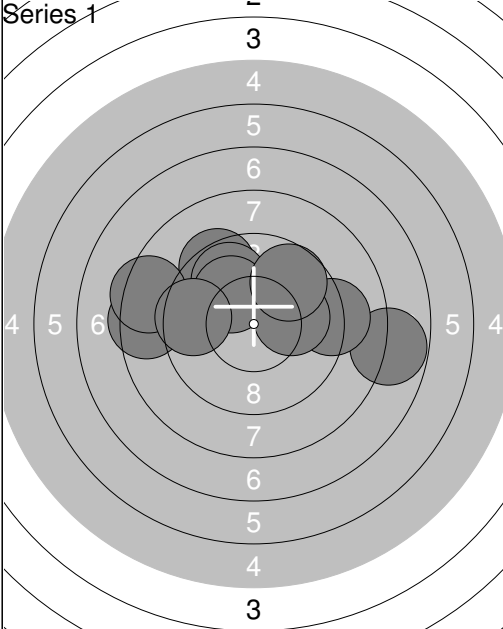
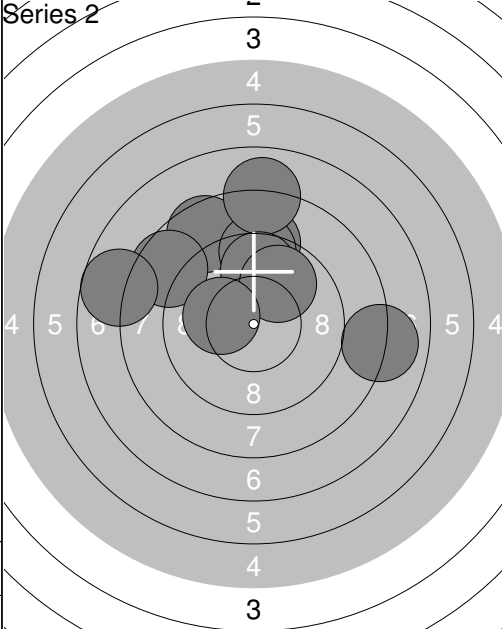
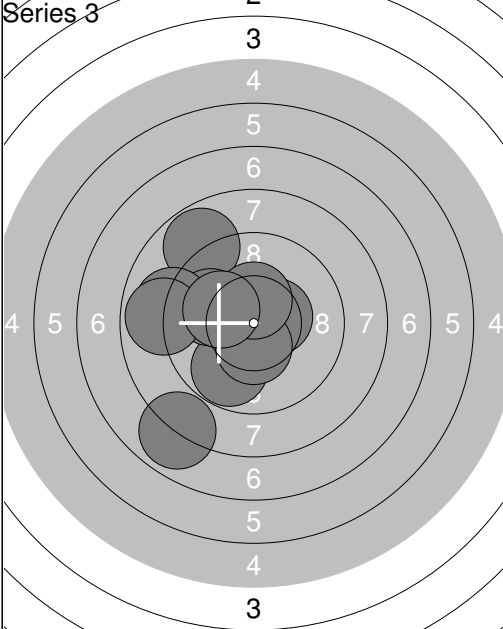
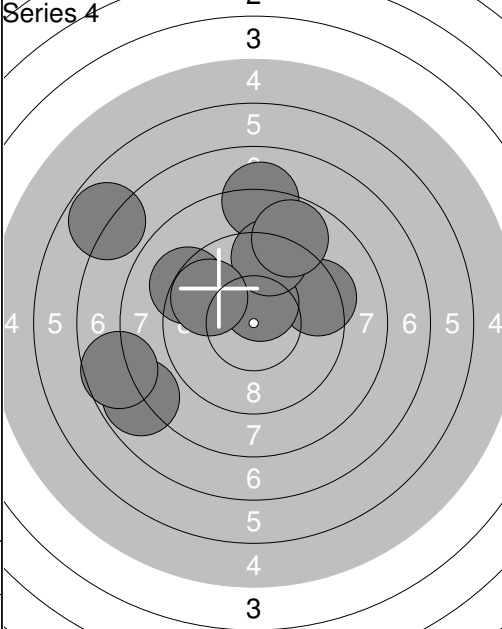
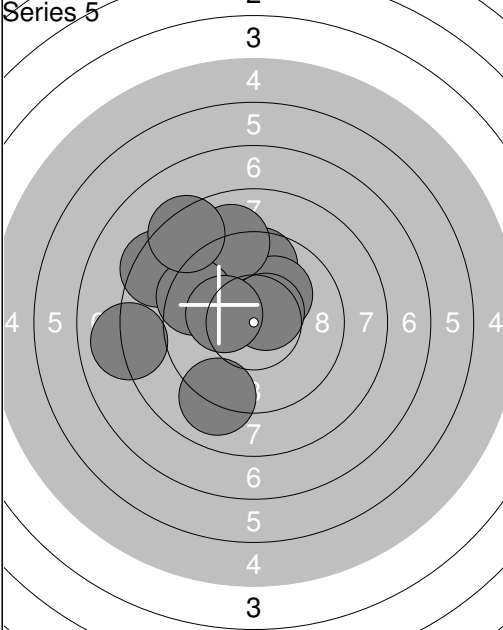
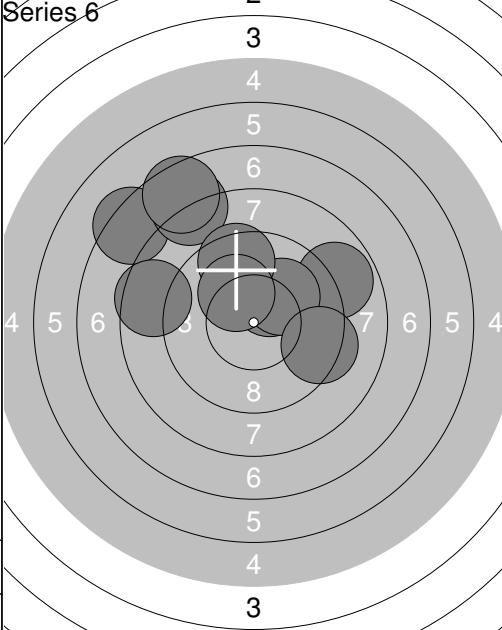
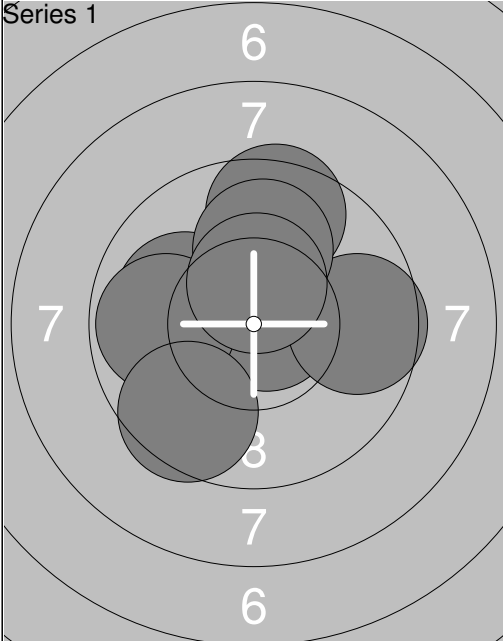
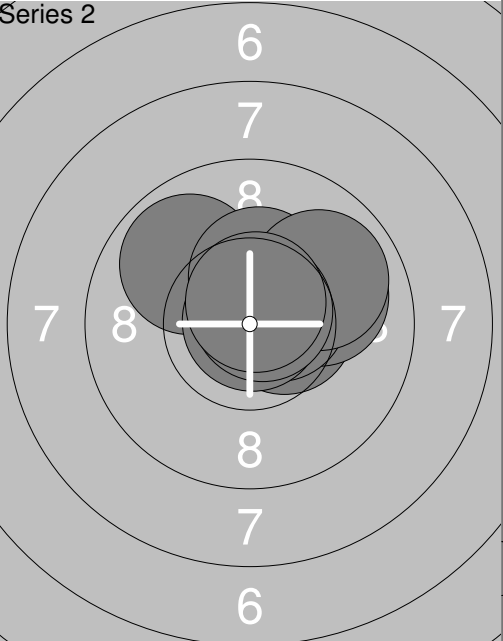
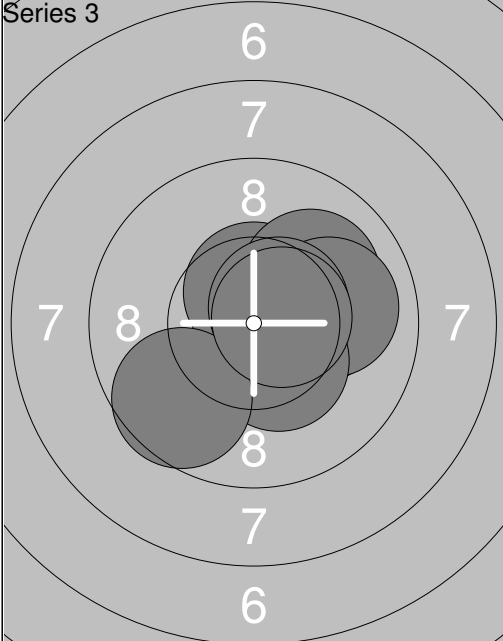
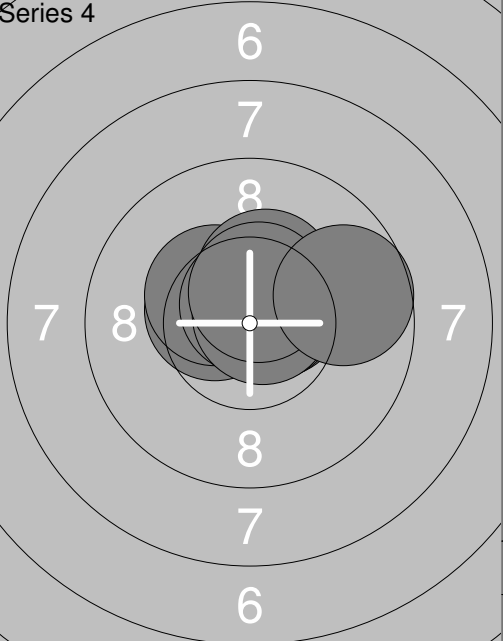
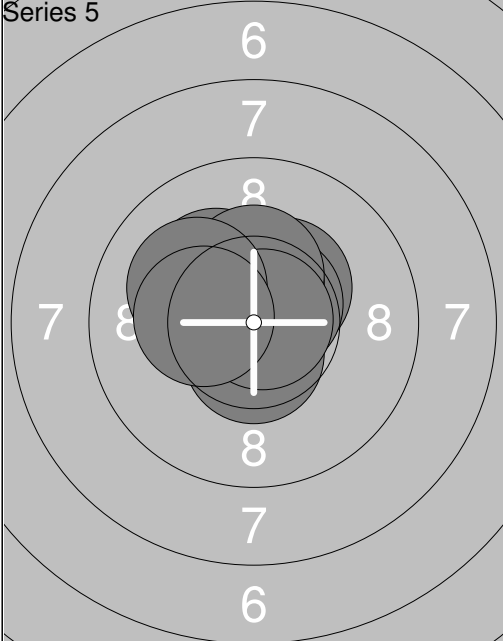
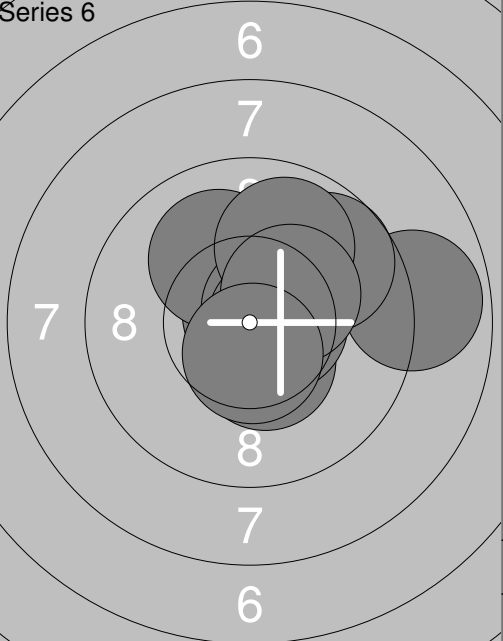
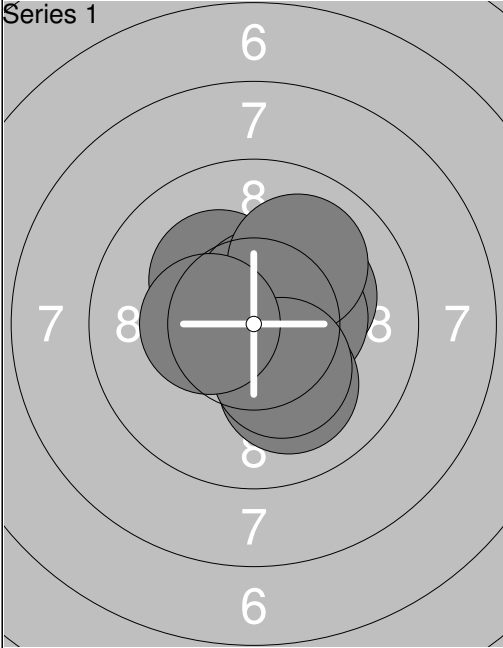
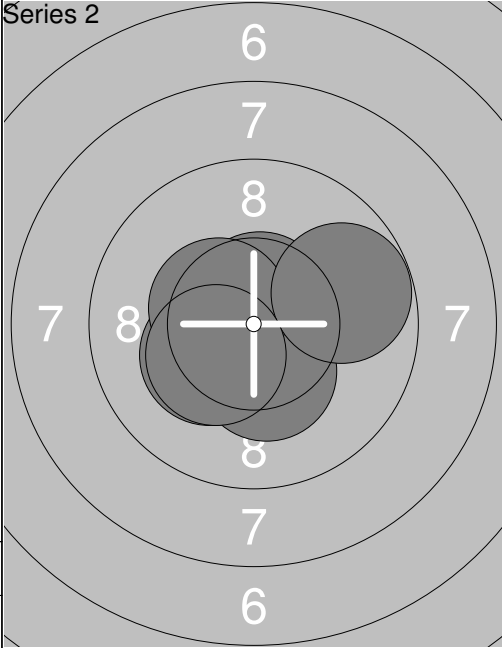
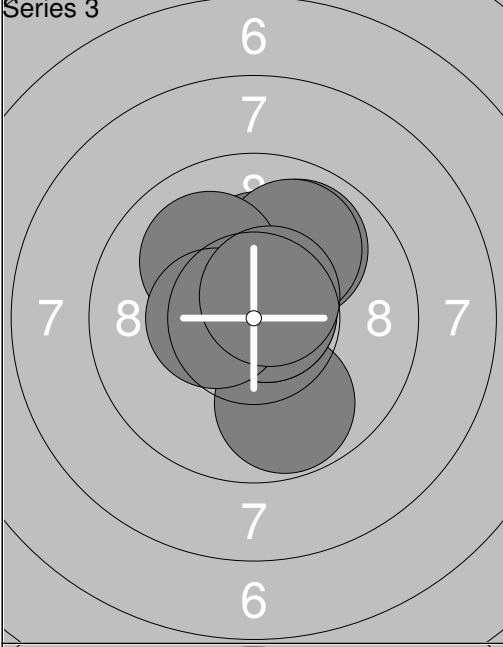
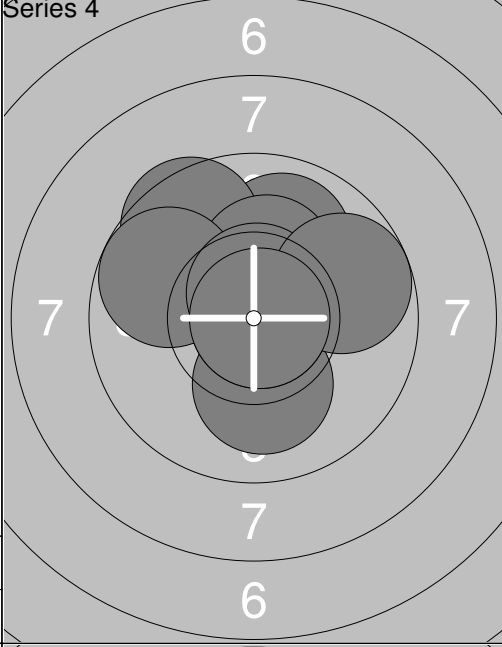
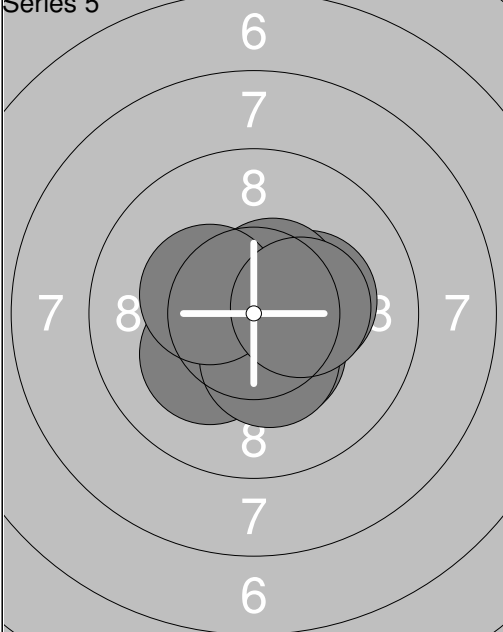
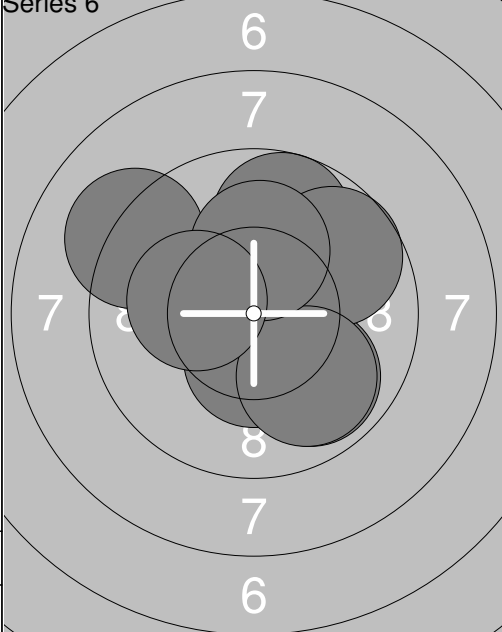
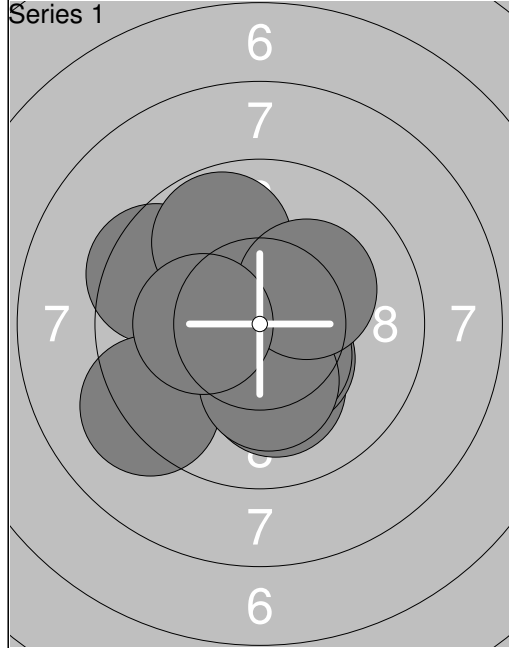

1:	10.6x↗
2:	9.5 ←
3:	9.8 ↗
4:	9.2 ↙
5:	10.1 ↓
6:	10.4x↘
7:	10.4x↘
8:	10.2x↓
9:	10.2x↗
10:	10.2x←
Series	100.6
	100.6

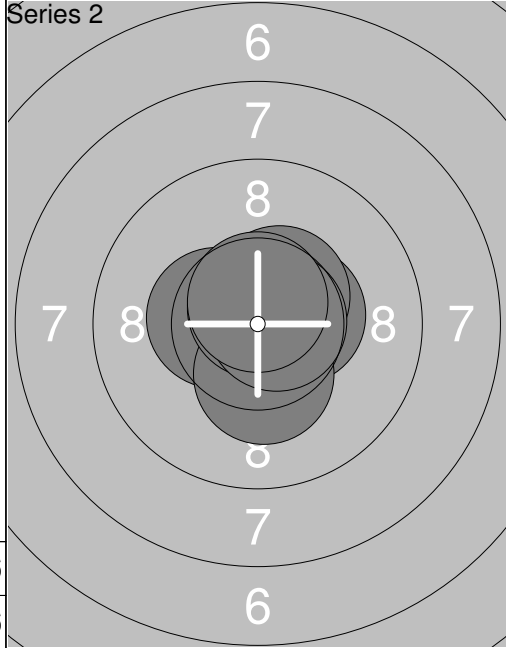

1:	10.4x➤
2:	10.6x↗
3:	10.8x➤
4:	10.6x↗
5:	10.4x↙
6:	10.5x↗
7:	10.3x↓
8:	10.7x↗
9:	10.7x➤
10:	10.7x↗
Series	105.7
	206.3

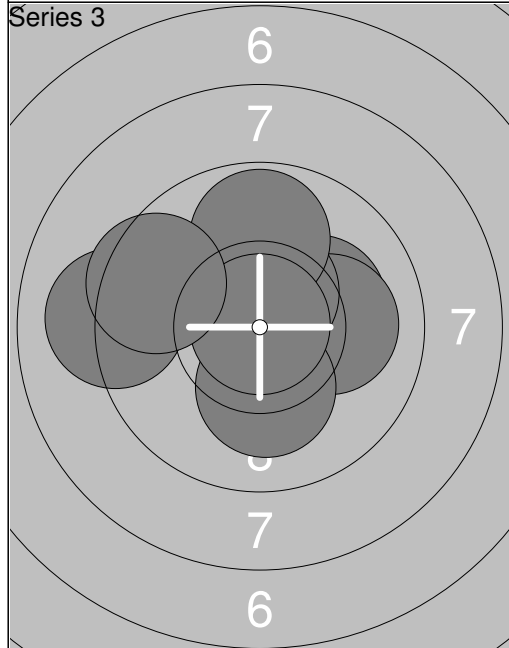

1:	10.5x➤
2:	9.1 ←
3:	10.2x➤
4:	10.6x↗
5:	10.0 ➔
6:	10.5x↗
7:	10.2x↓
8:	9.8 ↑
9:	10.9x↗
10:	9.5 ←
Series	101.3
	307.6

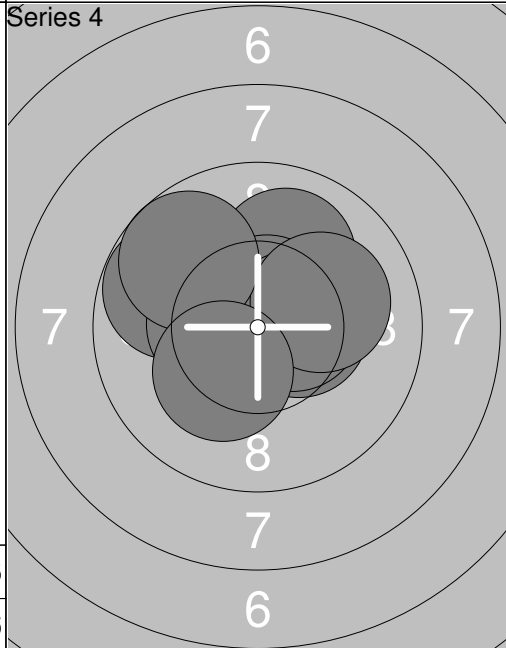

1:	9.8 ←
2:	10.4x↙
3:	10.3x↗
4:	10.0 ↗
5:	10.6x↗
6:	10.4x➤
7:	10.5x➤
8:	10.1 ➔
9:	9.7 ↙
10:	10.2x↘
Series	102.0
	409.6

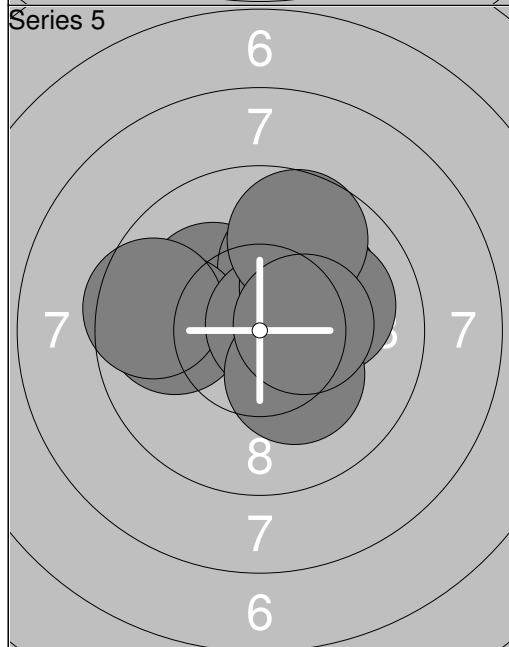

1:	10.2x↘
2:	10.0 ↗
3:	9.9 ←
4:	9.5 ←
5:	10.7x➤
6:	10.1 ↗
7:	10.0 ➔
8:	10.2x↘
9:	9.7 ↗
10:	10.4x➤
Series	100.7
	510.3

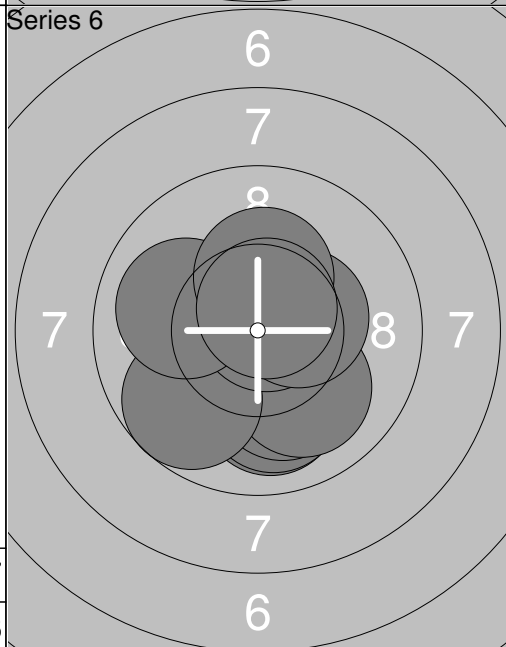

1:	10.0 ↓
2:	10.0 ↓
3:	10.1 ↓
4:	10.0 ↓
5:	9.7 ↙
6:	10.8x↗
7:	10.4x➤
8:	10.0 ↙
9:	10.2x↗
10:	10.6x↗
Series	101.8
	612.1

Relay	Lane	Riku Laitinen			
Air	HaaAS	ARJM			
19.11.2017	Superfinaali	Kankaanpään Ampumaurheilijat			
Series 1		1: 10.3x ↗	Series 2		1: 9.6 ↖
		2: 10.4x ↓		2: 10.2x ↓	2: 10.2x ↓
		3: 9.8 ↓		3: 8.9 ↖	3: 8.9 ↖
		4: 9.6 →	4: 10.5x ↗	4: 10.5x ↗	
		5: 10.0 ↖	5: 10.5x ↖	5: 10.5x ↖	
		6: 9.3 ↖	6: 9.9 ↗	6: 9.9 ↗	
		7: 10.5x ↗	7: 9.7 ↖	7: 9.7 ↖	
		8: 10.4x ↗	8: 9.4 ↗	8: 9.4 ↗	
		9: 9.9 ↖	9: 10.1 ↖	9: 10.1 ↖	
		10: 10.5x ↗	10: 10.6x ↗	10: 10.6x ↗	
	Series 100.7		Series 99.4		
	100.7		200.1		
Series 3		1: 10.5x ↗	Series 4		1: 10.2x ↘
		2: 10.9x ↗		2: 10.8x ↗	2: 10.8x ↗
		3: 9.9 ↗		3: 10.2x ↘	3: 10.2x ↘
		4: 10.4x ↘	4: 10.7x ↗	4: 10.7x ↗	
		5: 10.3x ↘	5: 9.7 ↖	5: 9.7 ↖	
		6: 10.7x ↗	6: 9.7 ↓	6: 9.7 ↓	
		7: 10.6x ↗	7: 10.2x ↗	7: 10.2x ↗	
		8: 10.2x ↗	8: 10.4x ↗	8: 10.4x ↗	
		9: 9.7 ↖	9: 10.3x ↘	9: 10.3x ↘	
		10: 9.0 ↖	10: 10.3x ↗	10: 10.3x ↗	
	Series 102.2		Series 102.5		
	302.3		404.8		
Series 5		1: 9.6 ↓	Series 6		1: 9.8 ↖
		2: 9.5 ↖		2: 10.5x ↗	2: 10.5x ↗
		3: 10.6x ↗		3: 10.0 ↗	3: 10.0 ↗
		4: 10.4x ↖	4: 10.7x ↗	4: 10.7x ↗	
		5: 8.8 ↖	5: 9.9 ↓	5: 9.9 ↓	
		6: 10.6x ↗	6: 10.5x ↗	6: 10.5x ↗	
		7: 10.5x ↗	7: 9.5 ↖	7: 9.5 ↖	
		8: 10.1 ↘	8: 10.0 ↑	8: 10.0 ↑	
		9: 10.6x ↗	9: 10.2x ↓	9: 10.2x ↓	
		10: 10.2x ↗	10: 10.6x ↗	10: 10.6x ↗	
	Series 100.9		Series 101.7		
	505.7		607.4		

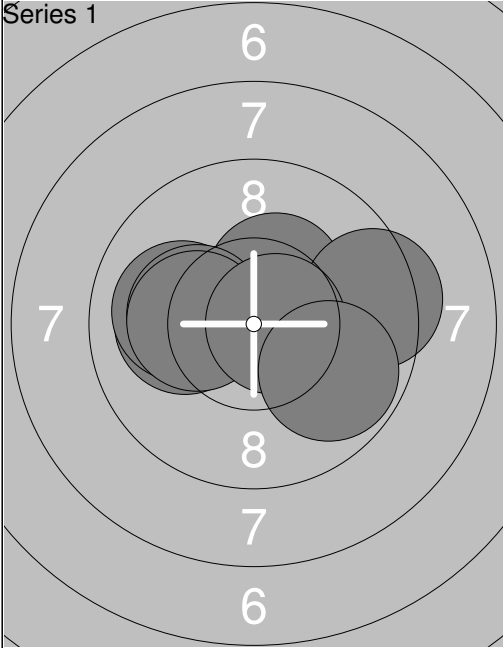
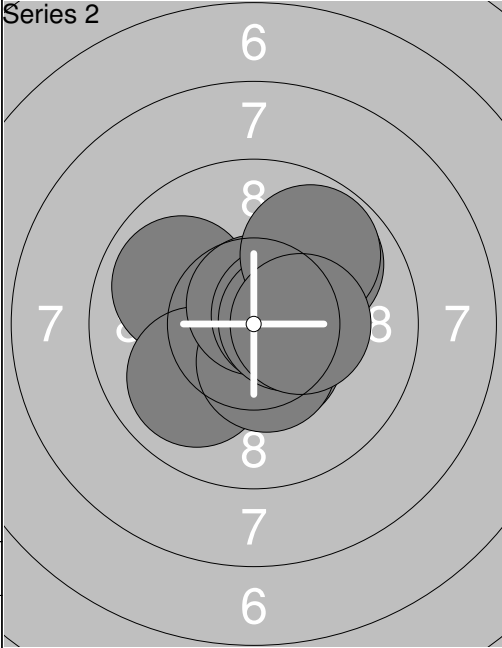
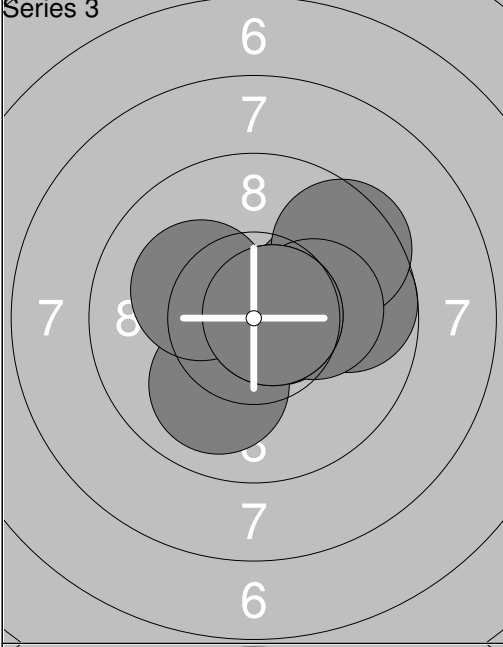
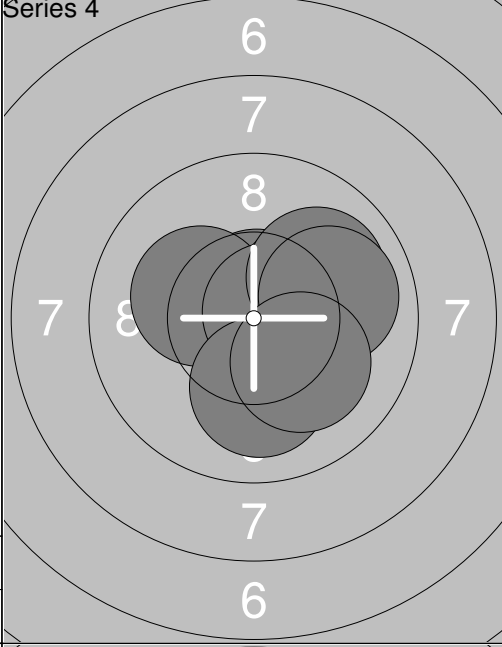
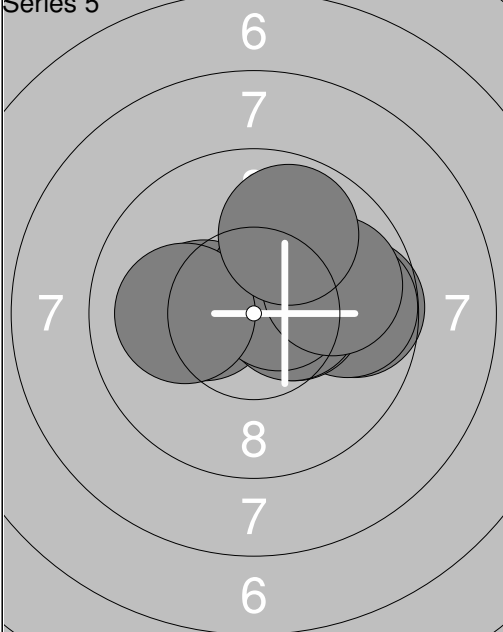
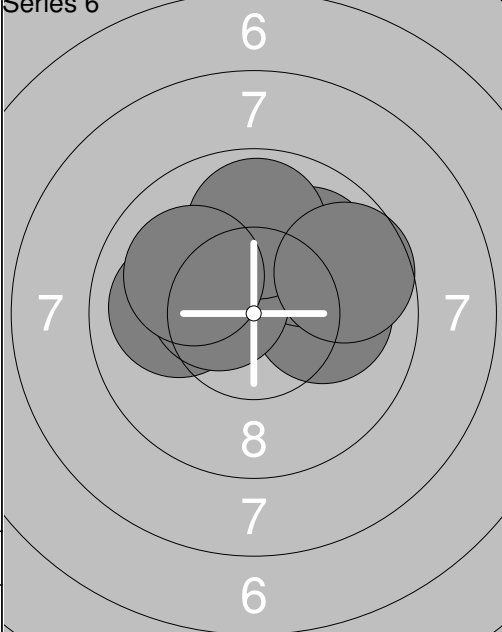
Relay	Lane	Mika Piipponen		
Air	KuusA	ARJM		
19.11.2017	Superfinaali	Kankaanpään Ampumaurheilijat		
Series 1		1: 10.8x↑ 2: 10.5x↗ 3: 10.1← 4: 10.0← 5: 10.3x↑ 6: 10.2x← 7: 10.2x← 8: 9.4 → 9: 10.6x> 10: 9.8 ↘ Series 101.9 101.9	Series 2 	1: 9.9 ↖ 2: 10.5x↓ 3: 9.9 ↙ 4: 10.4x↓ 5: 10.7x↑ 6: 10.5x> 7: 9.9 ↗ 8: 10.5x> 9: 9.8 ↗ 10: 10.3x> Series 102.4 204.3
Series 3		1: 10.6x> 2: 10.0 → 3: 9.7 → 4: 10.7x> 5: 10.0 ↓ 6: 9.5 ↗ 7: 10.2x> 8: 10.7x> 9: 10.2x← 10: 10.7x> Series 102.3 306.6	Series 4 	1: 10.7x↑ 2: 10.4x> 3: 10.2x> 4: 10.3x> 5: 10.2x← 6: 10.7x> 7: 10.0 ↓ 8: 10.0 ↗ 9: 9.9 → 10: 10.1 ↘ Series 102.5 409.1
Series 5		1: 9.6 → 2: 9.7 → 3: 10.4x> 4: 10.3x← 5: 10.5x↑ 6: 10.4x> 7: 10.6x> 8: 10.1← 9: 9.9 → 10: 9.9 ↑ Series 101.4 510.5	Series 6 	1: 10.2x← 2: 10.1 → 3: 10.3x↑ 4: 10.0 → 5: 9.9 ↗ 6: 10.0← 7: 10.4x← 8: 9.8 ↑ 9: 9.7 ↗ 10: 10.0↖ Series 100.4 610.9

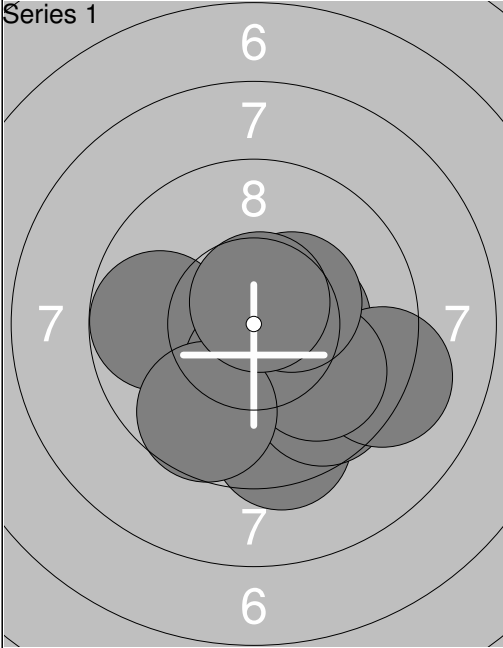
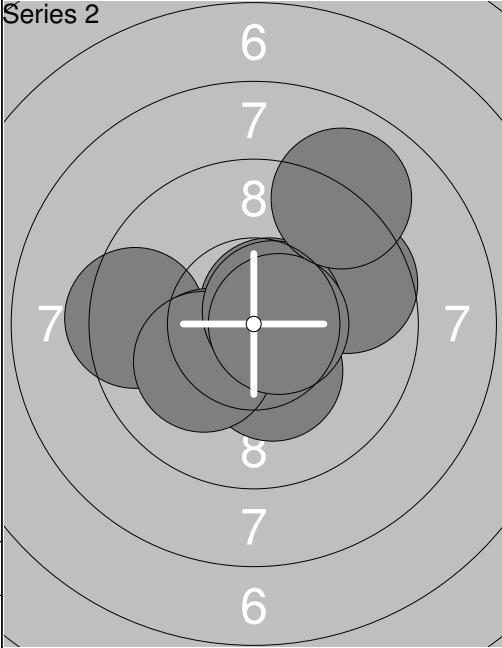
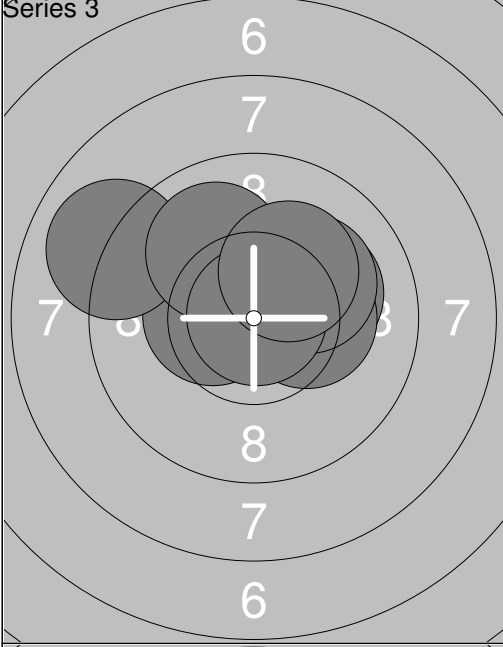
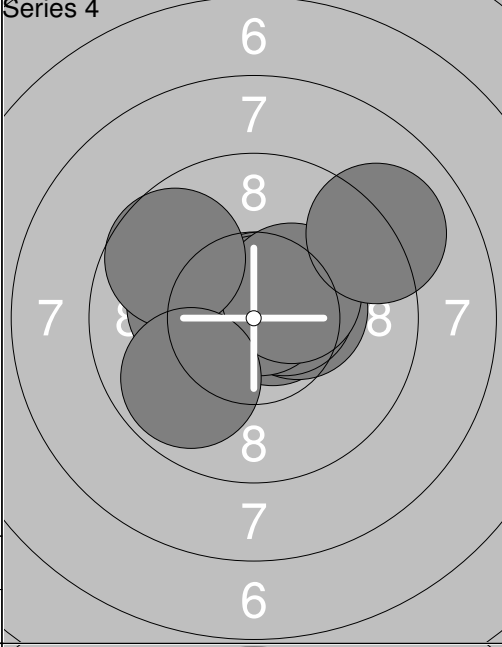
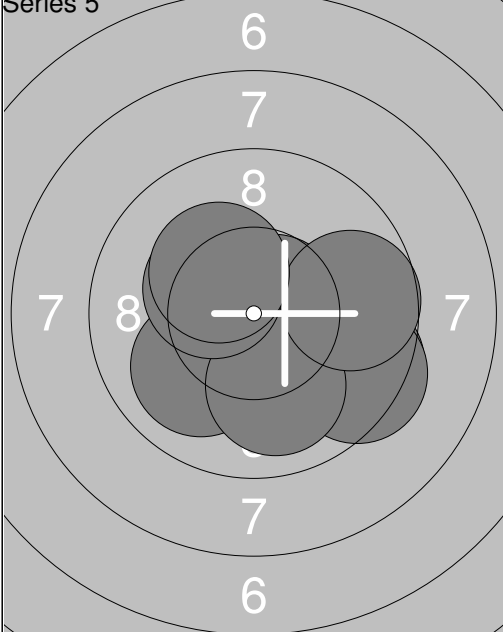
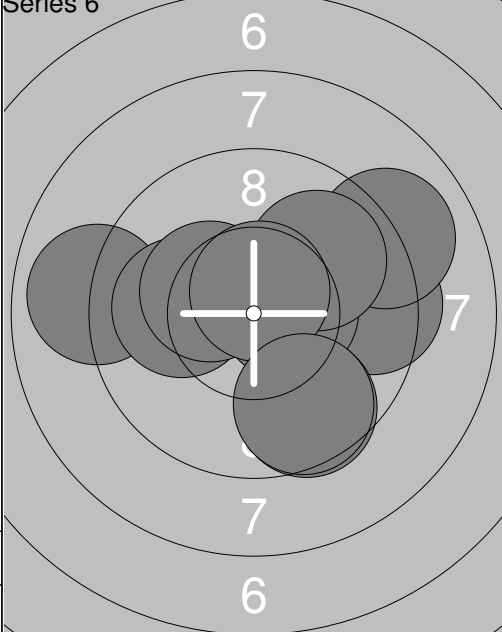
Relay	Lane			
1	20	Jimi Lång		
Air		KaA	ARJM	
19.11.2017	Superfinaali	Kankaanpään Ampumaurheilijat		
Series 1		1: 10.3x➤ 2: 9.4 ↓ 3: 9.7 ← 4: 10.4x↓ 5: 9.6 ↘ 6: 9.2 ➤ 7: 9.9 ↘ 8: 10.4x↗ 9: 9.7 ↓ 10: 10.7x↗ Series 99.3 99.3	Series 2 	1: 10.4x↓ 2: 10.6x↗ 3: 9.4 ← 4: 10.2x↘ 5: 10.3x↓ 6: 9.6 ➤ 7: 10.1 ↙ 8: 10.6x↗ 9: 10.6x➤ 10: 9.0 ↗ Series 100.8 200.1
Series 3		1: 10.5x➤ 2: 10.4x← 3: 9.0 ↙ 4: 10.1 ➤ 5: 10.3x➤ 6: 10.6x↗ 7: 10.0 ↘ 8: 10.1 ➤ 9: 10.9x↗ 10: 10.2x↗ Series 102.1 302.2	Series 4 	1: 10.7x➤ 2: 10.4x➤ 3: 10.5x➤ 4: 10.2x← 5: 10.7x↗ 6: 10.7x↗ 7: 10.3x↗ 8: 9.7 ↙ 9: 9.0 ➤ 10: 9.8 ↙ Series 102.0 404.2
Series 5		1: 9.7 ➤ 2: 10.7x↗ 3: 9.5 ➤ 4: 10.2x↓ 5: 9.4 ➤ 6: 10.0 ↙ 7: 10.0 ↓ 8: 9.7 ➤ 9: 10.3x↘ 10: 10.2x↘ Series 99.7 503.9	Series 6 	1: 9.4 ➤ 2: 8.9 ← 3: 10.5x➤ 4: 9.5 ↓ 5: 10.0← 6: 9.0 ➤ 7: 9.9 ↗ 8: 10.3x↘ 9: 10.6x↗ 10: 9.6 ↓ Series 97.7 601.6