

Relay	Lane	Riku Laitinen	
Air	HaaAS	ARJM	
18.11.2017	Kankaanpää Open	Kankaanpään Ampumaurheilijat	
Series 1 	1: 10.4x↖	Series 2 	1: 10.3x↘
	2: 10.3x↗		2: 9.8 ↗
	3: 9.6 →		3: 10.2x→
	4: 10.3x↗		4: 10.0 ↖
	5: 10.2x↗		5: 10.1 ↘
	6: 10.7x↗		6: 9.7 ↗
	7: 9.3 →		7: 8.9 ↙
	8: 10.7x↗		8: 9.5 →
	9: 10.3x→		9: 10.6x→
	10: 9.6 ↘		10: 9.9 ↙
	Series 101.4		Series 99.0
	101.4		200.4
Series 3 	1: 9.2 →	Series 4 	1: 9.1 →
	2: 9.4 ←		2: 9.9 ←
	3: 9.4 ←		3: 10.4x↘
	4: 10.4x↘		4: 9.7 ←
	5: 9.6 ←		5: 10.1 ↖
	6: 10.1 ↘		6: 10.5x↘
	7: 10.6x→		7: 10.1 ↙
	8: 9.4 ↖		8: 9.2 ↗
	9: 10.5x↗		9: 9.2 ←
	10: 9.8 ←		10: 10.6x→
	Series 98.4		Series 98.8
	298.8		397.6
Series 5 	1: 9.9 →	Series 6 	1: 10.0 ↘
	2: 9.7 →		2: 10.6x↗
	3: 10.3x↗		3: 10.1 ↖
	4: 9.9 →		4: 9.7 ←
	5: 10.4x↗		5: 10.7x↗
	6: 10.0 ↗		6: 9.7 ←
	7: 9.8 ↘		7: 10.6x→
	8: 9.7 →		8: 10.0 ↘
	9: 9.5 ←		9: 9.9 ↗
	10: 9.5 ↘		10: 10.4x↖
	Series 98.7		Series 101.7
	496.3		598.0

Relay	Lane	Mika Piipponen		
Air	KuusA	ARJM		
18.11.2017	Kankaanpää Open	Kankaanpään Ampumaurheilijat		
Series 1		1: 10.8x↑ 2: 10.7x↗ 3: 10.1↓ 4: 9.0→ 5: 9.5→ 6: 10.3x→ 7: 10.2x↘ 8: 10.3x↘ 9: 9.8↙ 10: 9.9↖ Series 100.6 100.6	Series 2 	1: 9.6↘ 2: 10.5x→ 3: 9.9→ 4: 9.3→ 5: 10.4x↙ 6: 10.3x↘ 7: 10.0→ 8: 10.5x↗ 9: 10.5x↗ 10: 10.1↖ Series 101.1 201.7
Series 3		1: 9.7↓ 2: 10.3x↗ 3: 10.6x→ 4: 10.3x↘ 5: 9.8↖ 6: 10.6x→ 7: 10.2x→ 8: 10.6x→ 9: 9.6↘ 10: 10.6x→ Series 102.3 304.0	Series 4 	1: 9.8↗ 2: 9.7→ 3: 10.0↓ 4: 10.6x↗ 5: 10.1↗ 6: 10.5x↘ 7: 10.1↘ 8: 10.7x↗ 9: 10.4x↗ 10: 10.5x↘ Series 102.4 406.4
Series 5		1: 9.7↑ 2: 9.9↘ 3: 9.4→ 4: 10.6x→ 5: 9.6↘ 6: 10.5x↗ 7: 10.7x↗ 8: 10.9x↗ 9: 10.4x→ 10: 9.7↘ Series 101.4 507.8	Series 6 	1: 10.0↘ 2: 10.0↖ 3: 8.9→ 4: 10.2x↗ 5: 10.0→ 6: 10.4x↘ 7: 9.8↙ 8: 9.7↖ 9: 10.2x↖ 10: 10.7x↗ Series 99.9 607.7

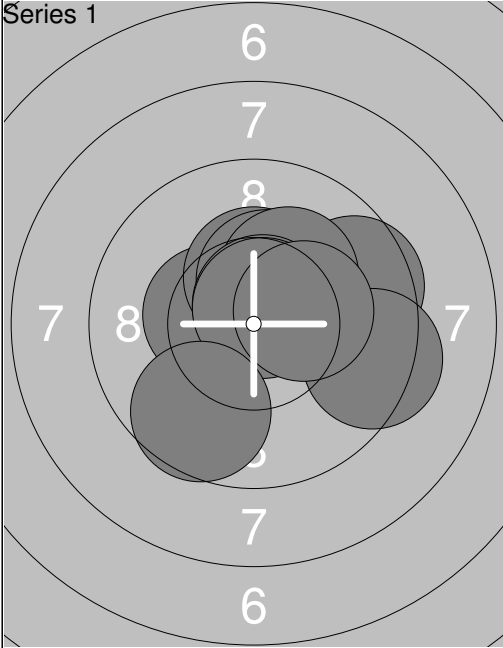
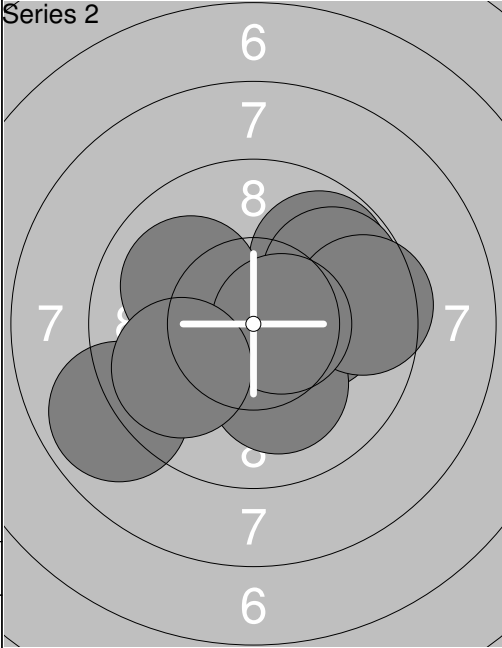
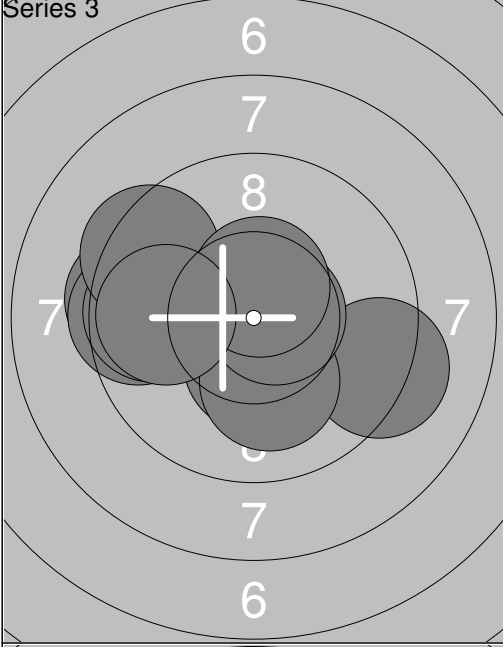
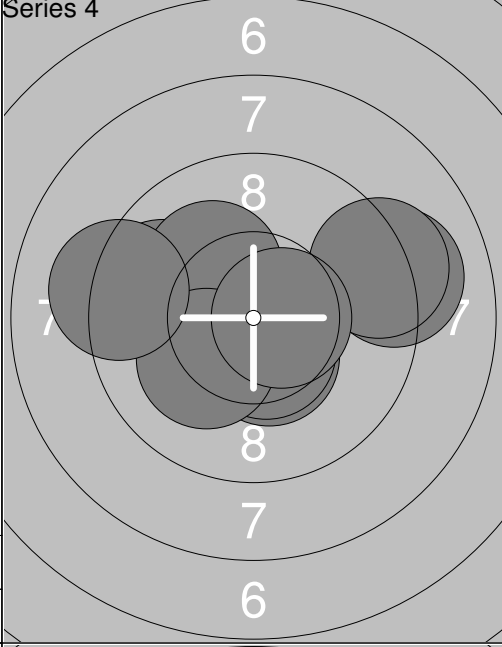
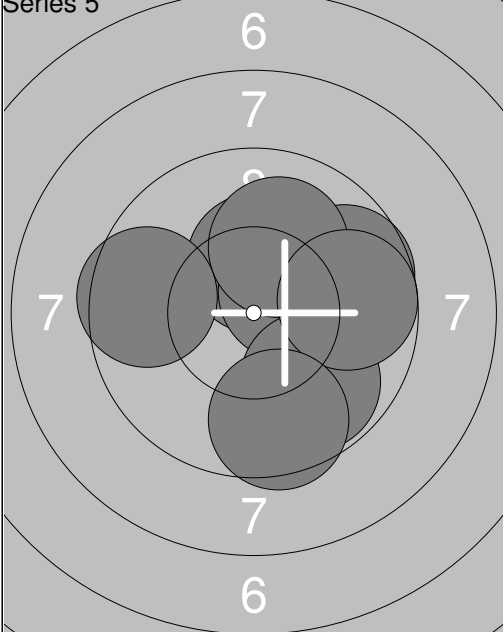
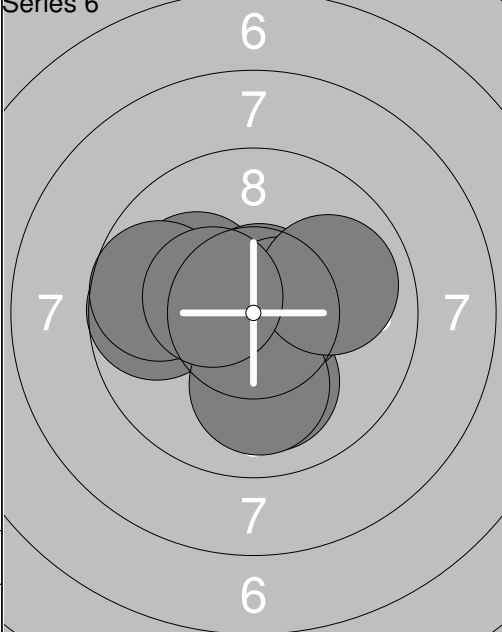
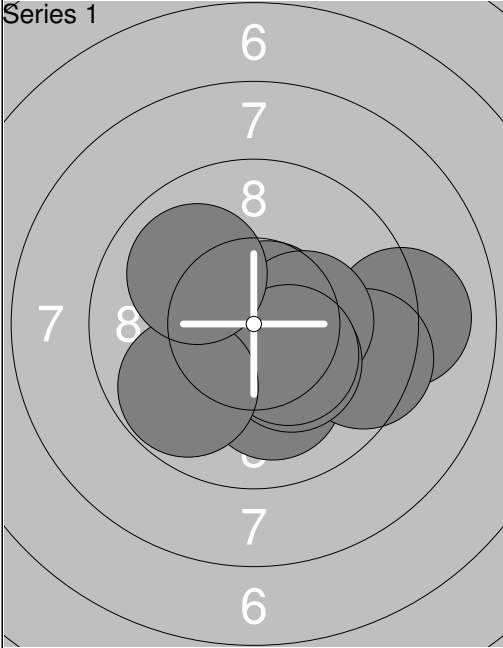
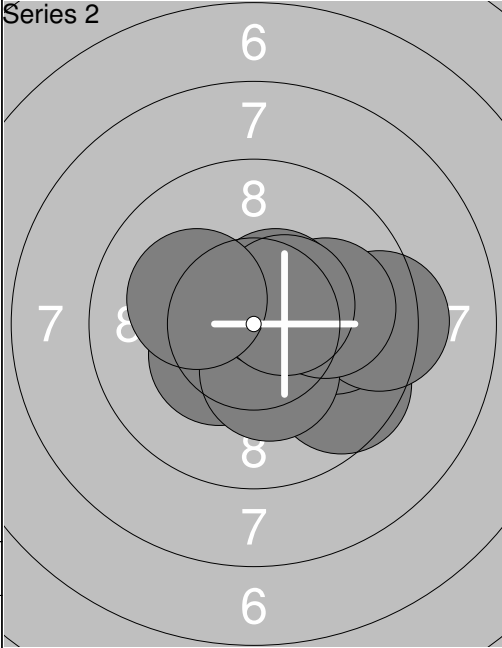
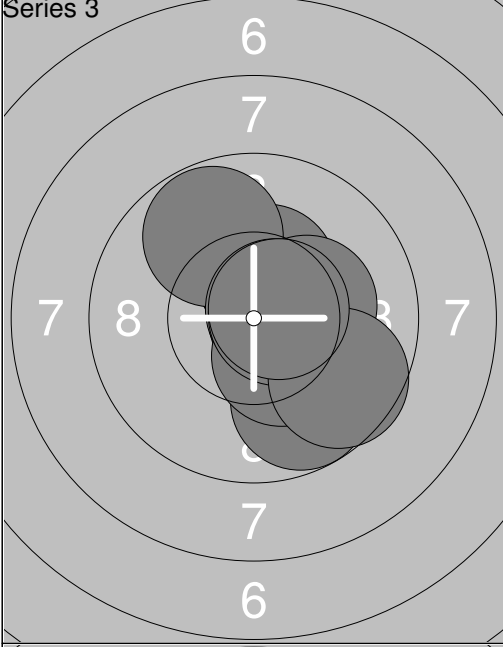
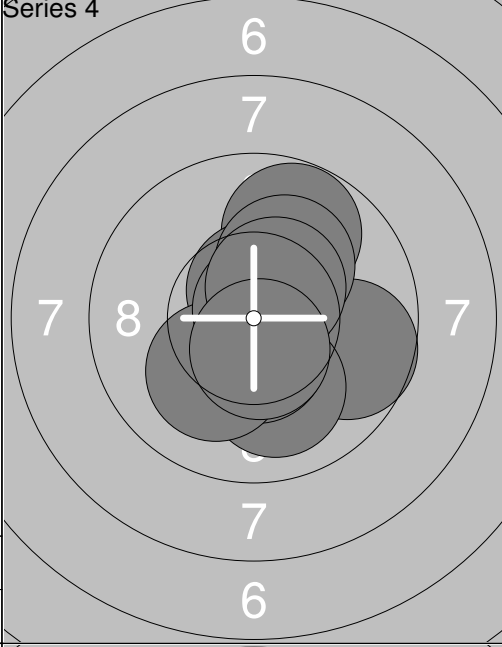
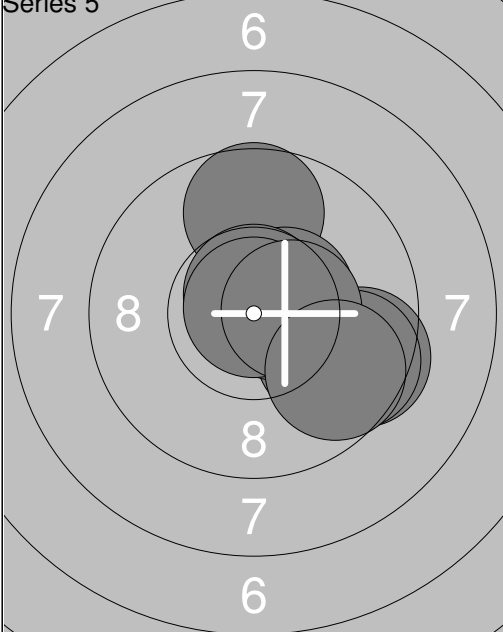
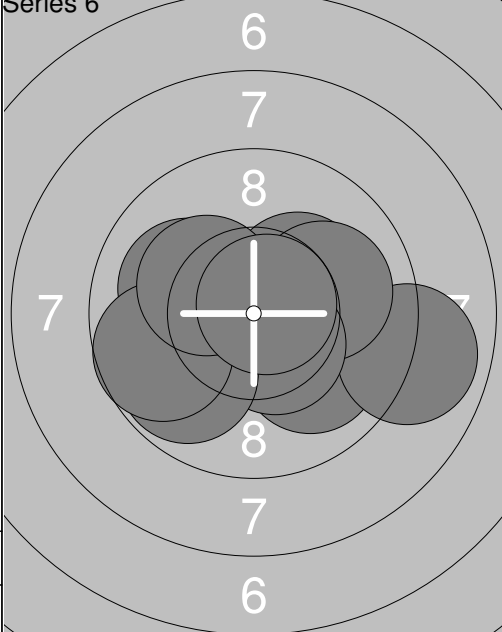
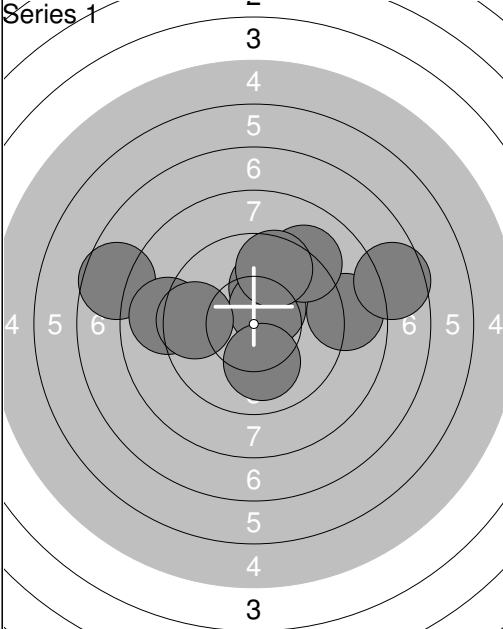
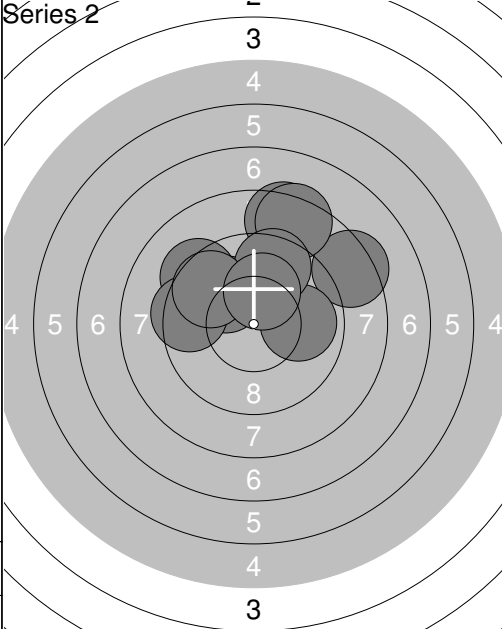
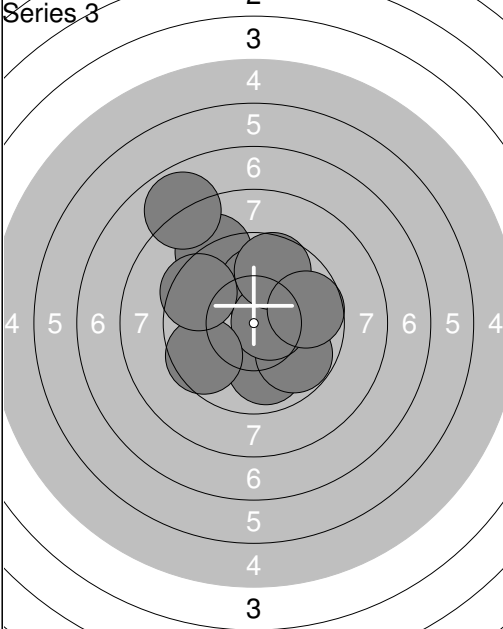
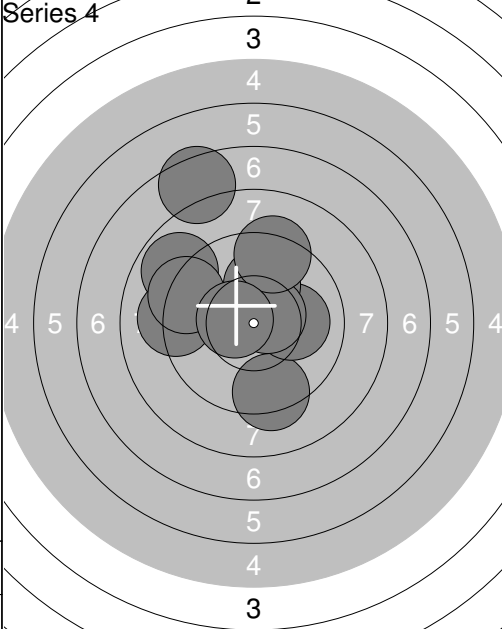
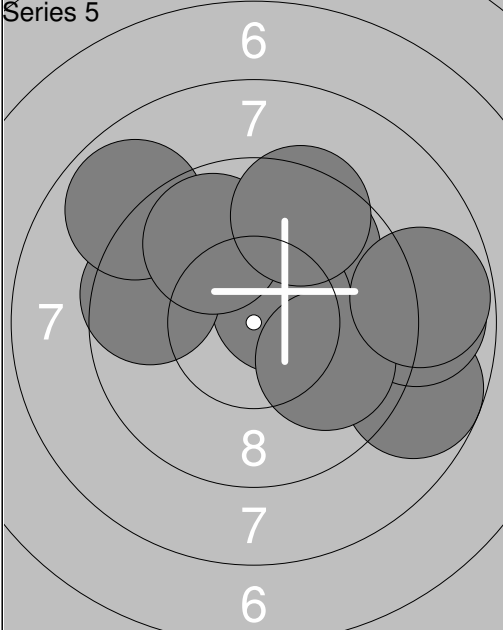
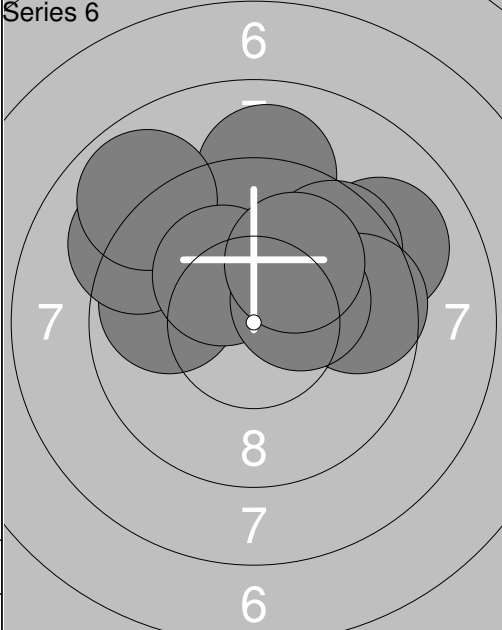

Relay	Lane	Luukas Koota			
Air	ESF	ARJM			
18.11.2017	Kankaanpää Open	Kankaanpään Ampumaurheilijat			
Series 1		1: 10.1 ↓	Series 2		1: 10.6x ↗
		2: 10.0 ↑			2: 9.8 ↘
		3: 9.9 ↑			3: 10.4x ↗
		4: 10.5x ↘		4: 10.5x ↘	
		5: 10.3x ↘		5: 9.3 ↙	
		6: 9.6 ↗		6: 10.6x ↗	
		7: 10.1 ↙		7: 10.1 ↙	
		8: 10.3x ↘		8: 9.9 ↓	
		9: 9.4 ↙		9: 10.4x ↘	
		10: 10.2x ↙		10: 9.7 ↗	
	Series	100.4		Series	101.3
		100.4			201.7
Series 3		1: 10.4x ↘	Series 4		1: 10.3x ↗
		2: 8.9 ↙			2: 9.7 ↑
		3: 10.0 ↙			3: 10.4x ↙
		4: 10.7x ↗		4: 9.3 ↗	
		5: 10.5x ↓		5: 9.2 ↙	
		6: 10.3x ↓		6: 10.0 ↗	
		7: 10.4x ↗		7: 9.0 ↑	
		8: 10.0 ↗		8: 10.5x ↓	
		9: 9.9 ↙		9: 9.4 ↙	
		10: 10.2x ↗		10: 10.4x ↗	
	Series	101.3		Series	98.2
		303.0			401.2
Series 5		1: 10.2x ↗	Series 6		1: 9.6 ↙
		2: 10.5x ↗			2: 10.0 →
		3: 10.6x ↗			3: 10.7x ↗
		4: 9.9 ↙		4: 10.2x ↗	
		5: 10.0 ↙		5: 9.6 ↙	
		6: 10.3x ↘		6: 10.2x ↘	
		7: 9.8 ↙		7: 10.7x ↗	
		8: 9.8 ↙		8: 10.7x ↗	
		9: 10.1 ↑		9: 9.8 ↙	
		10: 10.5x ↗		10: 8.8 ↑	
	Series	101.7		Series	100.3
		502.9			603.2

Relay	Lane	Niko Elonen	
Air	KaA	ARJM	
18.11.2017	Kankaanpää Open	Kankaanpään Ampumaurheilijat	
Series 1		1: 10.0 ↗ 2: 7.6 ↖ 3: 10.5x ↗ 4: 8.9 ↖ 5: 8.8 → 6: 9.1 ↗ 7: 9.5 ↗ 8: 7.6 → 9: 9.6 ↖ 10: 10.0 ↓	Series 91.6
			91.6
Series 2		1: 8.4 ↗ 2: 9.2 ↖ 3: 8.5 ↗ 4: 10.0 ↖ 5: 8.4 ↗ 6: 9.9 → 7: 9.5 ↗ 8: 9.4 ↖ 9: 9.6 ↖ 10: 10.1 ↗	Series 93.0
			184.6
Series 3		1: 9.9 ↓ 2: 9.8 ↘ 3: 9.1 ↗ 4: 10.0 ↗ 5: 7.9 ↗ 6: 10.6x → 7: 9.6 ↗ 8: 9.5 ↖ 9: 9.5 ↖ 10: 9.7 →	Series 95.6
			280.2
Series 4		1: 7.5 ↗ 2: 9.3 ↓ 3: 8.8 ↖ 4: 9.1 ↖ 5: 10.1 → 6: 10.0 ↗ 7: 10.6x ↗ 8: 9.3 ↗ 9: 9.2 ↖ 10: 10.5x ↖	Series 94.4
			374.6
Series 5		1: 8.7 → 2: 8.8 → 3: 9.8 ↗ 4: 10.5x ↗ 5: 9.9 ↘ 6: 9.6 ↖ 7: 8.8 → 8: 8.8 ↖ 9: 9.8 ↗ 10: 9.4 ↗	Series 94.1
			468.7
Series 6		1: 9.0 ↗ 2: 9.1 ↗ 3: 9.8 ↖ 4: 9.6 ↗ 5: 9.6 → 6: 9.1 ↖ 7: 8.8 ↖ 8: 10.2x ↖ 9: 10.3x ↗ 10: 10.0 ↗	Series 95.5
			564.2

Relay	Lane	Sebastian Långström			
Air	KSF	ARJM			
18.11.2017	Kankaanpää Open	Kankaanpään Ampumaurheilijat			
Series 1		1: 10.6x ↗	Series 2		1: 10.2x ↘
		2: 9.9 ↖			2: 9.6 ↙
		3: 9.7 →			3: 10.2x ↓
		4: 10.2x ↓		4: 10.6x ↗	
		5: 10.7x ↗		5: 10.7x ↗	
		6: 10.1 ↖		6: 10.2x ↗	
		7: 10.4x ↗		7: 9.9 ↗	
		8: 10.6x ↗		8: 10.1 ↓	
		9: 10.8x ↗		9: 10.7x ↗	
		10: 10.2x ↘		10: 10.6x ↗	
	Series 103.2		Series 102.8		
	103.2		206.0		
Series 3		1: 10.4x ↗	Series 4		1: 10.7x ↗
		2: 10.3x ↘			2: 10.1 ↓
		3: 10.8x ↗			3: 10.4x ↗
		4: 10.3x ↓		4: 10.6x ↗	
		5: 10.4x ↗		5: 9.8 →	
		6: 10.7x ↗		6: 10.5x ↓	
		7: 10.2x ↗		7: 10.3x ↗	
		8: 10.4x ↓		8: 9.9 →	
		9: 10.3x ↘		9: 10.4x →	
		10: 9.8 ↓		10: 10.8x ↗	
	Series 103.6		Series 103.5		
	309.6		413.1		
Series 5		1: 10.3x ↗	Series 6		1: 9.7 ↙
		2: 10.5x ↗			2: 10.3x ↗
		3: 10.6x ↗			3: 10.4x ↘
		4: 10.2x ↘		4: 10.5x ↗	
		5: 10.0 ↖		5: 10.8x ↗	
		6: 9.9 ↗		6: 9.8 ↙	
		7: 10.3x ↘		7: 9.9 ↓	
		8: 10.2x ↓		8: 10.4x ↓	
		9: 10.3x ↓		9: 10.4x ↘	
		10: 10.6x ↗		10: 10.4x ↓	
	Series 102.9		Series 102.6		
	516.0		618.6		

Relay	Lane	Jere-Juhani Salo			
Air	NoSA	ARJM			
18.11.2017	Kankaanpää Open	Kankaanpään Ampumaurheilijat			
Series 1		1: 9.9 →	Series 2		1: 9.6 →
		2: 10.6x↑			2: 9.8 ↑
		3: 10.5x↗			3: 10.4x↓
		4: 10.3x↓		4: 10.5x↑	
		5: 10.2x→		5: 9.9 ↖	
		6: 10.5x↗		6: 10.1↙	
		7: 10.6x↗		7: 10.3x↑	
		8: 10.0→		8: 10.7x→	
		9: 10.3x↖		9: 10.3x↗	
		10: 9.8 ←		10: 10.2x>	
	Series 102.7		Series 101.8		
	102.7		204.5		
Series 3		1: 10.2x↑	Series 4		1: 10.5x↖
		2: 10.0 ↓			2: 9.8 ↙
		3: 10.7x↗			3: 10.4x↓
		4: 10.1→		4: 10.2x↑	
		5: 9.9 →		5: 9.6 ↙	
		6: 10.0 ↗		6: 10.7x↗	
		7: 9.5 ↗		7: 10.1 ↘	
		8: 10.1 ↗		8: 10.5x↓	
		9: 10.6x↑		9: 10.3x↗	
		10: 10.6x↗		10: 10.2x↖	
	Series 101.7		Series 102.3		
	306.2		408.5		
Series 5		1: 10.3x↗	Series 6		1: 10.3x→
		2: 10.5x↓			2: 10.8x↑
		3: 10.8x↗			3: 10.5x↑
		4: 10.6x↗		4: 10.4x→	
		5: 10.6x→		5: 9.7 ↑	
		6: 9.7 ↑		6: 10.5x↗	
		7: 10.3x↑		7: 10.0→	
		8: 10.0 ↓		8: 10.3x↖	
		9: 9.9 ↗		9: 10.3x↗	
		10: 10.6x↑		10: 9.8 ↑	
	Series 103.3		Series 102.6		
	511.8		614.4		

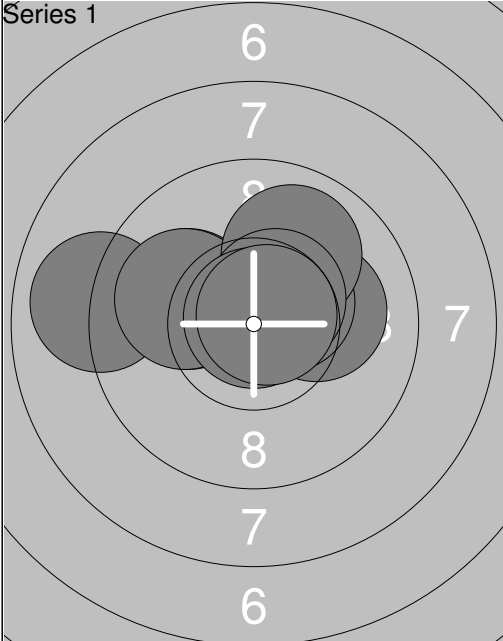
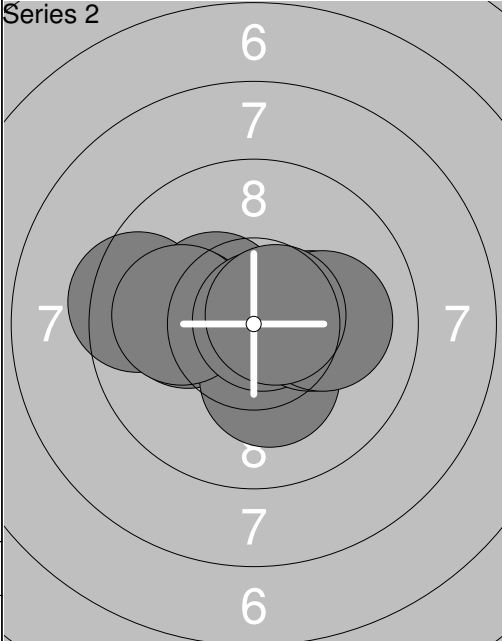
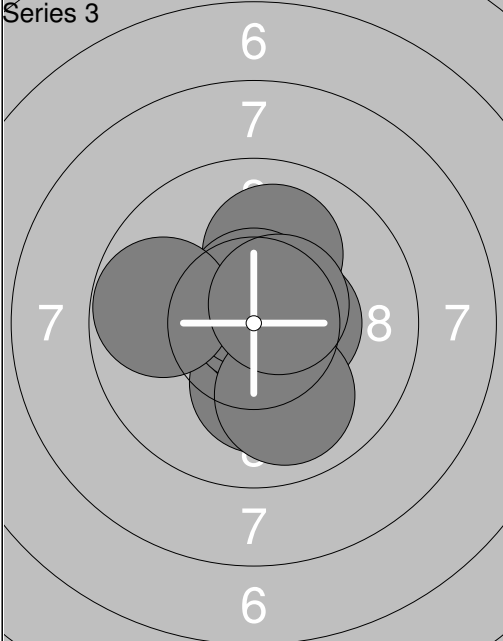
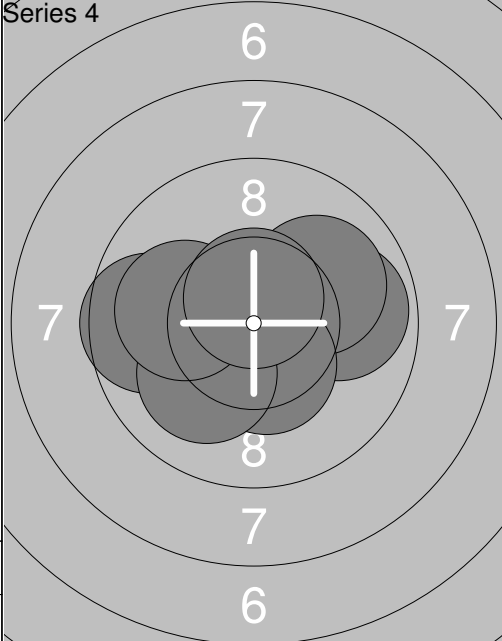
Relay	Lane	Jimi Lång				
Air	KaA	ARJM				
18.11.2017	Kankaanpää Open	Kankaanpään Ampumaurheilijat				
Series 1		1: 10.6x➤	Series 2	Series 2		1: 9.1 ←
		2: 10.3x⤴			2: 10.5x↗	
		3: 9.6 ↑			3: 9.9 ↓	
		4: 9.1 ↑		4: 9.3 ↓		
		5: 10.2x⤵		5: 10.6x➤		
		6: 10.0 ↗		6: 9.8 ↓		
		7: 10.3x⤵		7: 10.4x↖		
		8: 9.9 ↖		8: 10.1 ←		
		9: 10.5x➤		9: 9.6 ↘		
		10: 10.5x↗		10: 9.6 ↗		
	Series 101.0		Series 98.9			
	101.0		199.9			
Series 3		1: 10.5x⤴	Series 4	Series 4		1: 9.9 ➤
		2: 10.3x↖			2: 10.2x↖	
		3: 10.1 ➤			3: 10.8x⤴	
		4: 10.1 ↑		4: 9.6 ↖		
		5: 9.9 ➤		5: 9.8 ↗		
		6: 9.8 ↑		6: 10.5x⤵		
		7: 10.5x↗		7: 10.3x↗		
		8: 10.6x➤		8: 10.2x➤		
		9: 9.5 ↗		9: 10.7x➤		
		10: 10.0 ←		10: 10.5x↗		
	Series 101.3		Series 102.5			
	301.2		403.7			
Series 5		1: 10.4x➤	Series 6	Series 6		1: 10.5x➤
		2: 10.0 ➤			2: 10.7x↗	
		3: 9.1 ←			3: 10.5x↗	
		4: 10.0 ➤		4: 10.4x↖		
		5: 9.5 ↘		5: 10.3x⤵		
		6: 10.0 ↑		6: 10.2x⤴		
		7: 9.8 ↑		7: 9.6 ➤		
		8: 8.5 ←		8: 10.6x➤		
		9: 10.5x↗		9: 10.8x↗		
		10: 9.4 ↗		10: 10.6x➤		
	Series 97.2		Series 104.2			
	500.9		605.1			

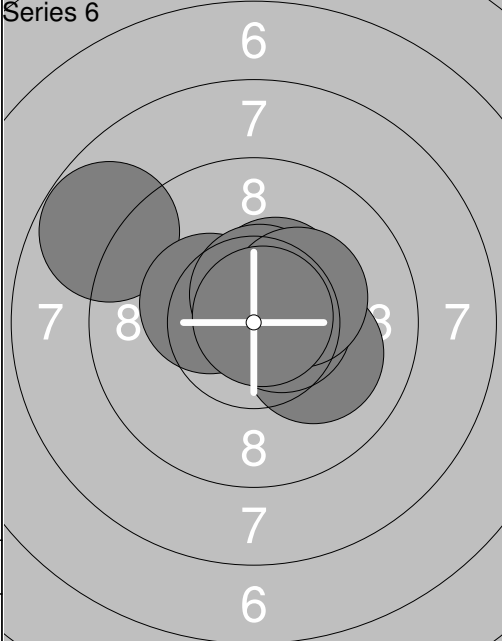
Relay	Lane	Matias Kiuru				
Air	PAS	ARJM				
18.11.2017	Kankaanpää Open	Kankaanpään Ampumaurheilijat				
Series 1		1: 10.1 →	Series 2	Series 2		1: 9.4 ←
		2: 9.0 ←			2: 10.4 ✕	
		3: 10.0 ←			3: 10.1 ←	
		4: 10.8x ↗		4: 10.7x →		
		5: 10.0 ←		5: 10.2x ↓		
		6: 10.4x ↗		6: 10.0 ←		
		7: 9.9 ↗		7: 10.8x →		
		8: 10.5x ↗		8: 10.2x →		
		9: 10.8x ↗		9: 10.0 →		
		10: 10.7x ↗		10: 10.6x →		
	Series 102.2		Series 102.4			
	102.2		204.6			
Series 3		1: 10.5x ↓	Series 4	Series 4		1: 9.8 →
		2: 10.2x ↓			2: 10.7x ↗	
		3: 10.8x →			3: 10.5x ←	
		4: 10.0 ↗		4: 10.9x ↗		
		5: 10.4x →		5: 10.0 ↗		
		6: 10.8x ↗		6: 9.6 ←		
		7: 10.6x ↗		7: 10.4x ↓		
		8: 9.9 ↓		8: 10.1 ↓		
		9: 9.8 ←		9: 10.0 ←		
		10: 10.5x ↗		10: 10.6x ↗		
	Series 103.5		Series 102.6			
	308.1		410.7			
Series 5		1: 10.2x ↗	Series 6	Series 6		1: 8.8 ←
		2: 10.9x ↗			2: 10.7x ↗	
		3: 10.8x →			3: 10.8x ↗	
		4: 10.8x ↗		4: 10.4x ↗		
		5: 10.3x ↓		5: 10.3x ✕		
		6: 10.4x ↓		6: 10.1 →		
		7: 10.8x ↗		7: 10.6x →		
		8: 10.2x ✕		8: 10.6x ↗		
		9: 10.2x ✕		9: 10.3x ↗		
		10: 8.4 ↓		10: 10.8x ↗		
	Series 103.0		Series 103.4			
	513.7		617.1			



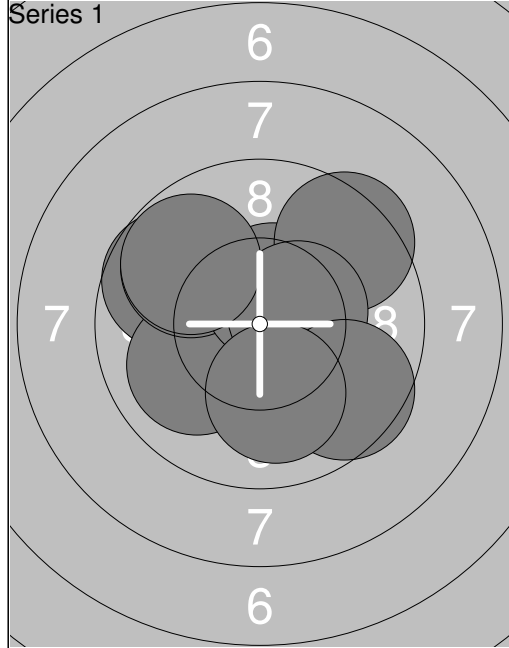

1:	9.7	↖
2:	10.0	↙
3:	9.8	↖
4:	10.5	↗
5:	10.5	↗
6:	9.4	↗
7:	10.4	↗
8:	9.7	↖
9:	9.6	↘
10:	10.0	↓
Series	99.6	
	99.6	

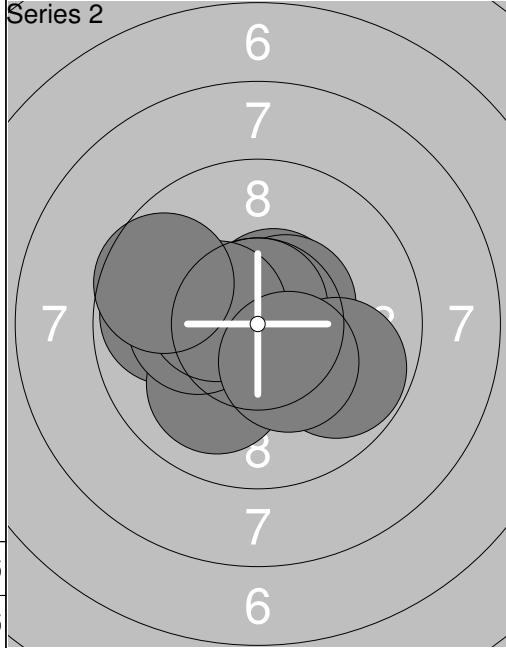

1:	9.8	←
2:	10.5	↗
3:	10.0	↘
4:	10.5	↗
5:	10.2	←
6:	10.7	↗
7:	10.4	←
8:	9.8	↘
9:	10.3	↘
10:	9.6	←
Series	101.8	
	201.4	

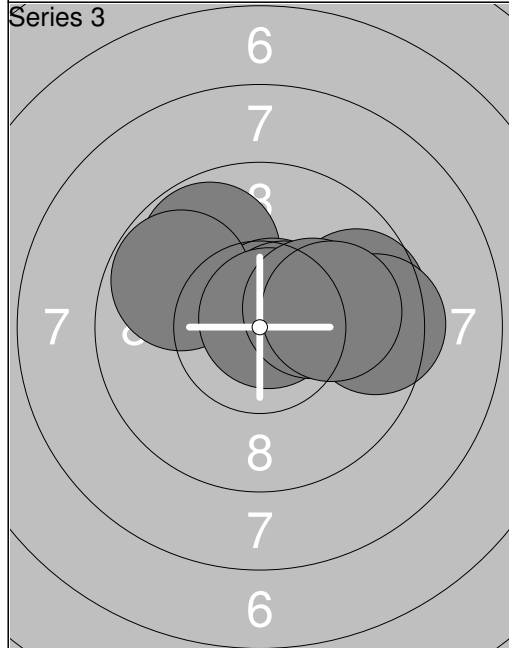

1:	10.6	↗
2:	9.8	↖
3:	10.6	↗
4:	10.5	↗
5:	9.8	↖
6:	9.6	→
7:	9.4	→
8:	10.7	↗
9:	10.2	↗
10:	10.0	→
Series	101.2	
	302.6	

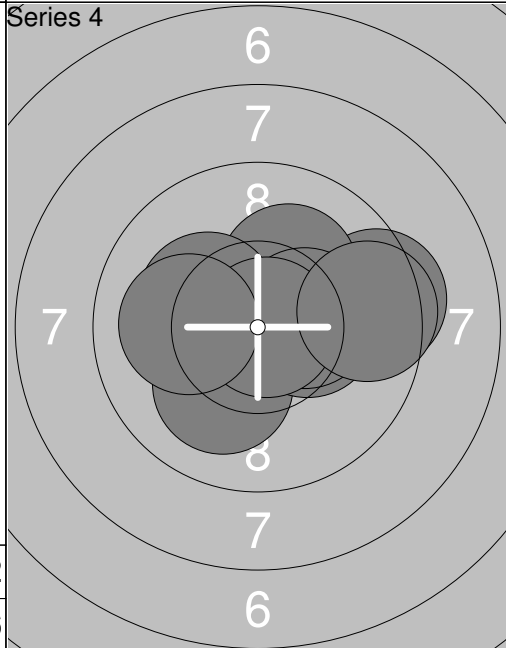

1:	10.3	↗
2:	9.4	→
3:	10.1	↗
4:	10.1	↘
5:	10.3	↗
6:	10.2	←
7:	10.3	↗
8:	10.8	↗
9:	9.5	→
10:	10.1	←
Series	101.1	
	403.7	

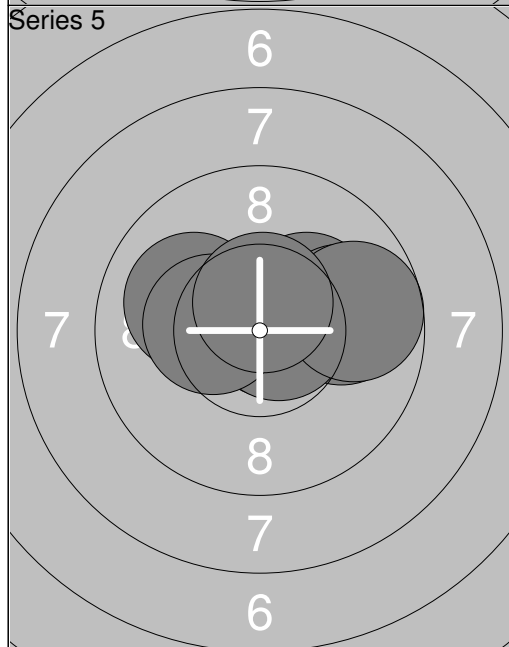

1:	10.6	↗
2:	10.2	↗
3:	10.8	↗
4:	10.3	←
5:	9.9	→
6:	10.0	←
7:	10.7	↗
8:	9.7	→
9:	10.3	←
10:	10.6	↗
Series	103.1	
	506.8	

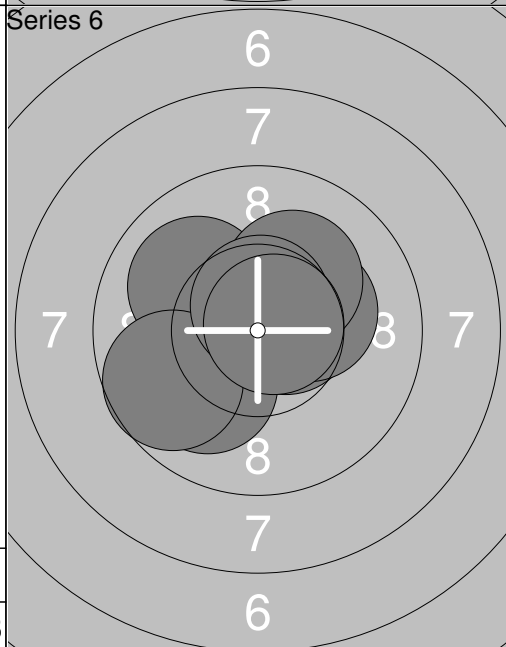

1:	10.0	↘
2:	10.4	←
3:	10.0	↖
4:	10.6	↗
5:	10.6	↗
6:	10.2	↗
7:	10.2	↗
8:	9.7	↖
9:	10.6	↗
10:	10.7	↗
Series	103.0	
	609.8	

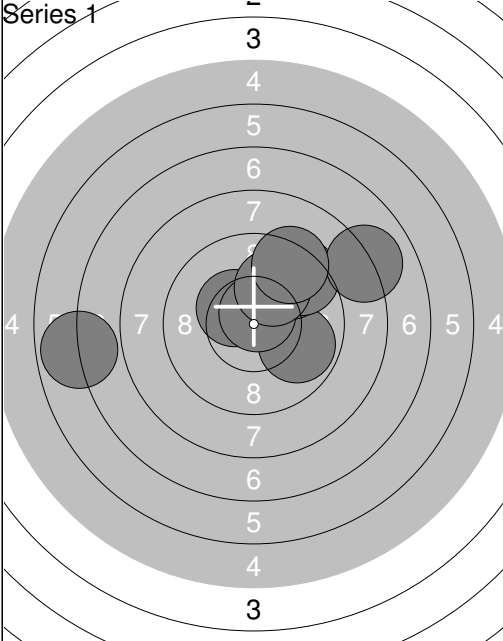
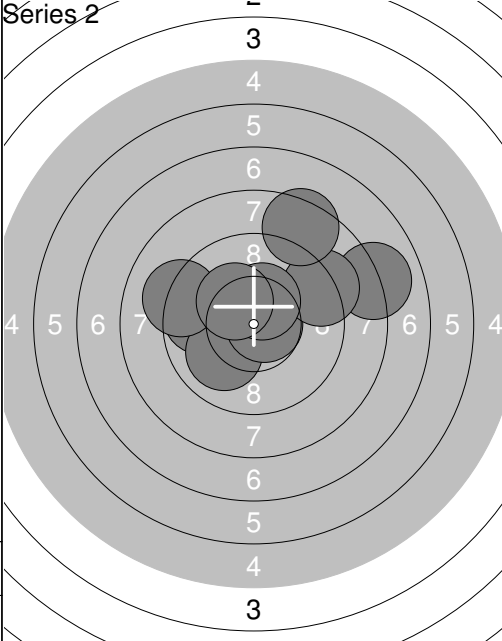
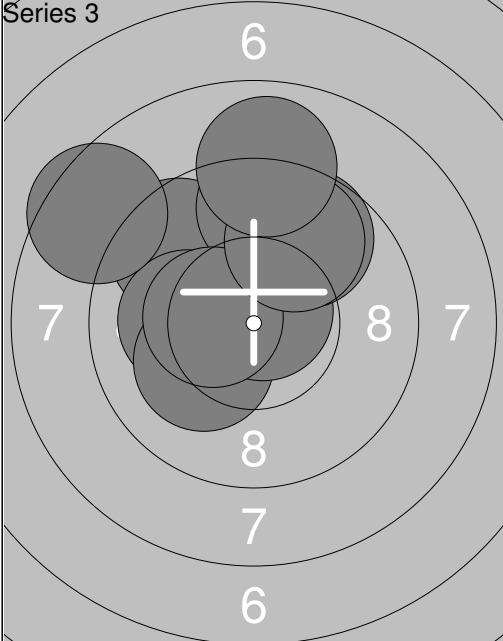
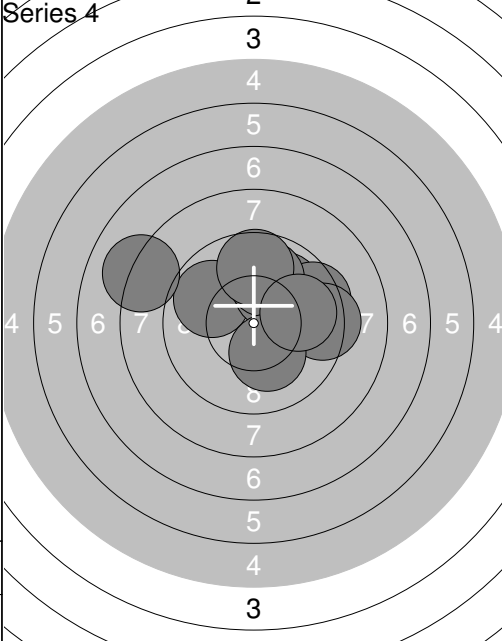
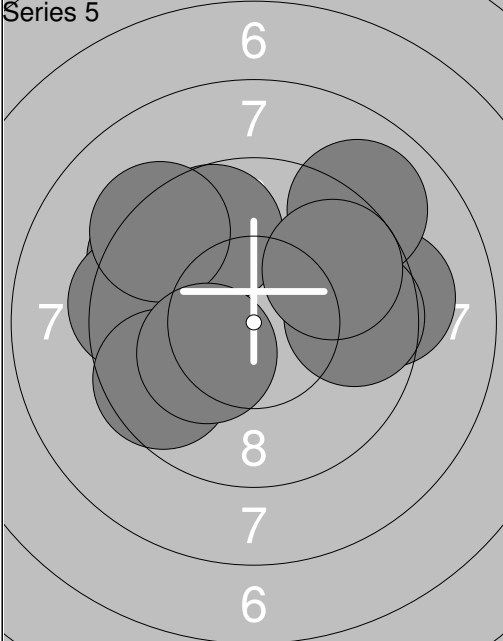
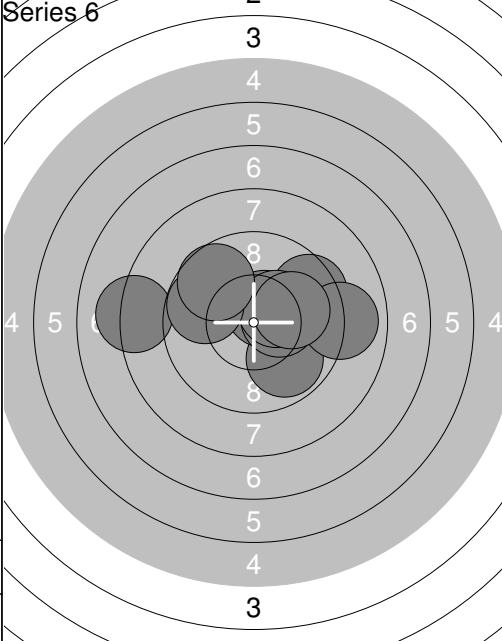
Relay	Lane	Mikko Helenius	
1	23	NoSA	ARJM
18.11.2017	Kankaanpää Open	Kankaanpään Ampumaurheilijat	
Series 1		1: 10.5x ↗ 2: 9.8 ➔ 3: 10.4x ↘ 4: 9.6 ↗ 5: 10.7x ↗ 6: 9.4 ↗ 7: 8.0 ➔ 8: 10.0 ↗ 9: 6.9 ← 10: 9.3 ↗ Series 94.6 94.6	Series 2  1: 9.7 ← 2: 10.6x ↗ 3: 10.0 ↘ 4: 8.0 ➔ 5: 10.7x ➔ 6: 9.2 ↗ 7: 9.1 ← 8: 10.4x ↗ 9: 8.5 ↗ 10: 10.2x ↘ Series 96.4 191.0
Series 3		1: 9.6 ↘ 2: 10.1 ← 3: 9.4 ↑ 4: 10.1 ↘ 5: 10.7x ↗ 6: 8.5 ↘ 7: 9.7 ↗ 8: 10.4x ↘ 9: 9.8 ↗ 10: 8.9 ↑ Series 97.2 288.2	Series 4  1: 9.8 ← 2: 8.1 ↘ 3: 10.0 ↗ 4: 9.9 ↗ 5: 9.5 ➔ 6: 9.3 ➔ 7: 9.8 ↗ 8: 9.7 ↑ 9: 10.2x ↘ 10: 9.9 ➔ Series 96.2 384.4
Series 5		1: 9.5 ↘ 2: 9.4 ← 3: 9.2 ➔ 4: 9.0 ↗ 5: 9.7 ↗ 6: 9.6 ➔ 7: 9.7 ↗ 8: 9.6 ↘ 9: 9.3 ↘ 10: 10.2x ↘ Series 95.2 479.6	Series 6  1: 9.5 ↗ 2: 9.8 ↘ 3: 8.2 ← 4: 10.5x ↗ 5: 8.9 ➔ 6: 10.3x ➔ 7: 10.3x ↗ 8: 10.0 ➔ 9: 9.8 ← 10: 9.6 ↘ Series 96.9 576.5